

REV	DESCRIPTION	DATE	APPR

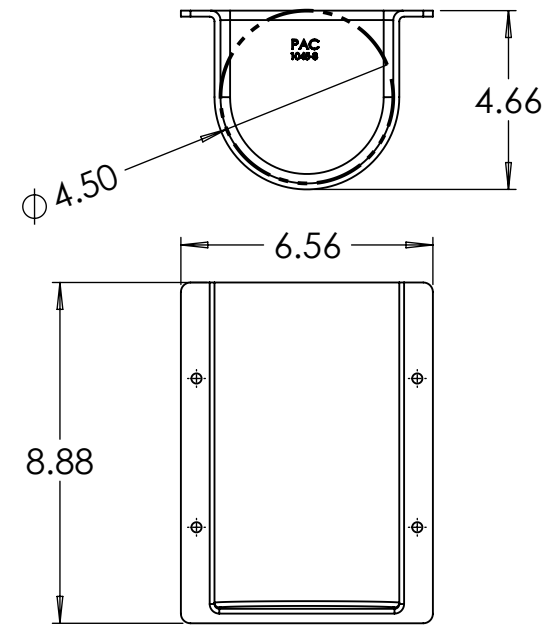
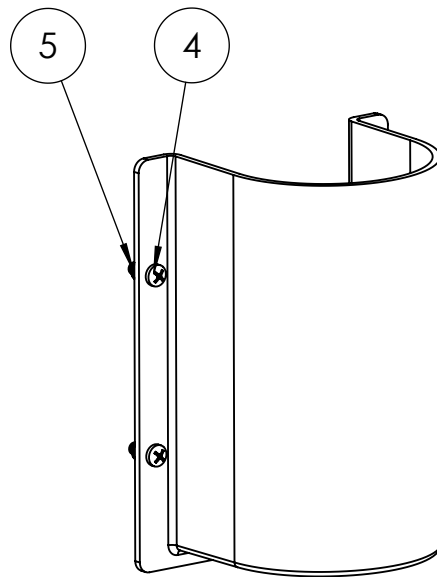
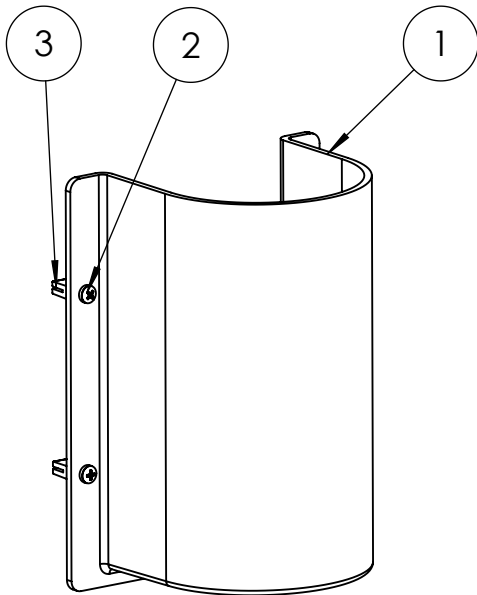

5	2069LN	1/4-20 NYLON LOCK NUT	4
4	2098	14-20 X 34 PHIL PANHEAD	4
3	7016	TRAC LOK INSERT	4
2	2049	#10-24 X 3/4 PAN HEAD SCREW	4
1	1045-3P	4-1/2" CYLINDER MOUNT (TALL)	1
ITEM NO.	PAC P/N	PART NAME	QTY

NOTES:

**PERFORMANCE
ADVANTAGE
COMPANY**



TOLERANCES UNLESS OTHERWISE SPECIFIED

.X= ±.03
.XX= ±.010
.XXX= ±.005
.XXXX= ±0.0005
ANGLES ±0.5 °
FRACTIONAL ±1/64

THIRD ANGLE PROJECTION



COLOR

NAME	DATE
DRAWN BY	
APPR. BY	
MFG BY	
MFG. P/N	
ENG APPR.	
MATERIAL	
ALT. MATERIAL	
FINISH	

THE INFORMATION CONTAINED IN THIS DRAWING IS THE SOLE PROPERTY OF PERFORMANCE ADVANTAGE CO. ANY REPRODUCTION IN PART OR AS A WHOLE WITHOUT THE WRITTEN PERMISSION OF PERFORMANCE ADVANTAGE CO. IS PROHIBITED.

TITLE:

4-1/2" CYLINDER MOUNT

PART NUMBER

1045-3

REV

SCALE: 1:4

SHEET 1 OF 1