



THE *TUFLEX* DIFFERENCE

All *Lift-All* slings meet or exceed OSHA and ASME B30.9 standards and regulations

Round
Slings

What is a *Tuflex* Roundsliding?

A *Tuflex* roundsliding is an endless synthetic sling made from a skein of polyester yarn covered by a double-wall tubular jacket. The roundsliding body can be compared to sling webbing with the tubular jacket face yarns woven without binder yarns. This allows the core yarns to move independently within the jacket.

Tufhide Jacket on EN360 and Larger Slings

The double-wall *Tufhide*™ jacket (made from bulked nylon fibers) offers better abrasion resistance for our larger capacity *Tuflex* Slings. Additionally, *Tufhide* reduces the heat buildup that can damage other high capacity roundslings when used in a choker hitch.

Features and Benefits

Promotes Safety

- Lightweight to reduce fatigue and strain on riggers.
- Synthetic materials won't cut hands.
- Consistent matched lengths for better multiple sling load control.
- No loss of strength from abrasion to cover.
- *Tuff-Tag* provides serial numbered identification for traceability.
- Low stretch (about 3% at rated capacity).
- Synthetic web resists marring of the load.
- Good for low headroom lifts.
- Conforms to shape of load to grip securely.

- Tubular jacket protects load bearing yarns from UV degradation.
- Red core yarns provide added visual warning of sling damage.
- Color-coding provides positive sling capacity information.

Saves Money

- Double-wall cover for greater sling life.
- The soft cover won't scratch the load surface.
- Conforms to shape of the load for reduced load damage.
- The cover is seamless with no sewn edges, preventing rupture which requires removal from service.
- EN360 and larger *Tuflex* roundslings feature *Tufhide* wear-resistant nylon jacket for extra sling life.
- *Tuff-Tag* provides required OSHA information for the life of the sling.

Saves Time

- Color-coded capacities for quick identification.
- Lightweight and pliable for easy rigging and storage.
- Independent core yarns choke tightly but release easily after use.
- Easy to carry.

⚠ WARNING
Follow temperature and chemical information located in the WEB section of this catalog.

Always protect synthetic slings from being cut or damaged by corners, edges and protrusions by using protection sufficient for each application.



Refer to Sling Protection section in this catalog.

CONSTRUCTION COMPARISONS

Tuflex Sleaving versus Sling Webbing

Tuflex Sleaving

- Transverse pick yarns position surface yarns and protect core yarns.
- Woven surface yarns protect core yarns, but carry no load.
- Longitudinal core yarns carry 100% of load.
- Red core warning yarns.



Tuflex Sleeve
(Side View)

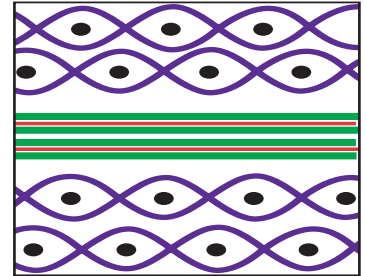

Roundslings construction (as shown above), protects all load carrying core yarns from abrasion with an independent, woven jacket. Replacement is not necessary until the red or white core yarns can be seen through holes in the jacket. When core yarns are visible, the sling must be removed from service. *Tuflex* roundslings provide double-wall protection for extended sling life.

Sling Webbing

- Transverse pick yarns inter-relate with binder yarns.
- Woven surface yarns cover each side and carry a portion of the load.
- Strip of longitudinal core yarns bears majority of load.
- Binder yarns secure the surface yarns to web core yarns.
- Red core warning yarns.

Sling Webbing
Side View

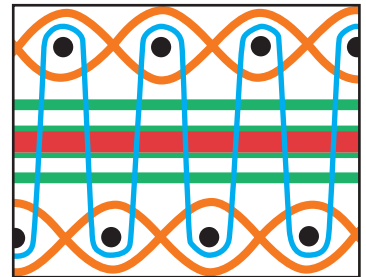

Sling webbing (as graphically demonstrated), has its surface yarns connected from side to side, to not only protect the core yarns but to position all surface and tensile yarns to work together to support the load. Wear or damage to sling webbing face yarns cause an immediate strength loss. This is the reason why sling webbing has red core yarns to visually reveal damage and act as a basis for sling rejection.

HOW TO ORDER

1. Specify sling part number found in the charts throughout the *Tuflex* section.
 2. Specify sling length in feet (bearing point to bearing point). Refer to footnotes under *Tuflex* tables for specific sling lengths and tolerances.
 3. Matched lengths of slings must be specified at time of order.
- Endless and Eye & Eye styles of *Tuflex* are made to a tolerance of $\pm (1" + 1\%$ of the specified length), and can stretch 3% at rated capacity.
 - Braided *Tuflex* length tolerance is $\pm (2" + 5\%$ of the ordered length with sling at rest). At its rated capacity, braided *Tuflex* will stretch approximately 9%.

* Prior to sling selection and use, please review and understand the General Information section in this catalog.

USING TUFLEX ROUNDSLINGS

Protect Sling from Damage

ALWAYS protect roundslings from being cut or damaged by corners, edges and protrusions using protection sufficient for each application.

Do not ignore warning signs of misuse. **Cut marks detected during any sling inspection serve as a clear indication that cut protection is needed.** Refer to Sling Protection section of our catalog.

Exposure of slings to edges

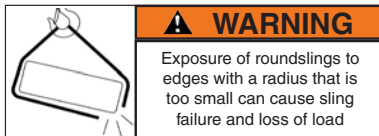

Edges do not need to be sharp to cause failure of the sling. The following table shows the minimum allowable edge radii suitable for contact with unprotected roundslings. Chamfering or cutting off edges is not an acceptable substitute for fully rounding the edges to the minimum radius. Slings can also be damaged from contact with edges or burrs at the sling connection.

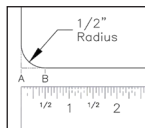

Measure the edge radius. The radius is equal to the distance between points A and B.

Minimum Edge Radii Suitable For Contact With Unprotected Polyester Roundslings		
Rated Capacity Vertical (lbs.)	Minimum* Edge Radii (in.)	Sling Width @ Load (in.)
EN30	0.19	1.00
EN60	0.25	1.38
EN90	0.31	1.75
EN120	0.31	1.88
EN150	0.38	2.00
EN180	0.44	2.13
EN240	0.44	2.63
EN280	0.44	3.00
EN360	0.50	3.25
EN460	0.57	3.75
EN600	0.69	4.00
EN800	0.75	4.63
EN900	0.80	5.00
EN1000	0.88	5.25
EN1100	0.92	5.50

* For further information on minimum edge radii, contact Lift-All or see WSTDA-RS-1.

Sling Hardware and Connections

Connection surfaces must be smooth to avoid abrading or cutting slings. Roundslings can be damaged or weakened by excessive compression between the sling and the connection points. Select and use proper connection hardware that conforms to the size requirements listed for choker, vertical, or basket hitches in the charts below.

Contact Lift-All (or see WSTDA-RS-1), for information about how to calculate whether a smaller connection size is allowable when tension on a roundslings is less than its capacity.

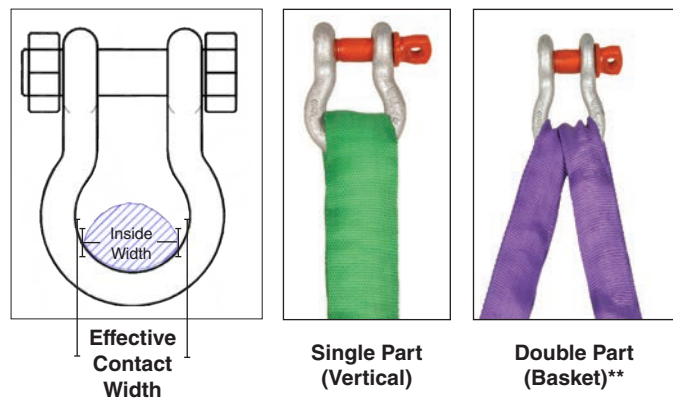

Minimum Hardware Dimensions Suitable For Use With Tuflex Roundslings				
Tuflex Size	Single Part		Double Part**	
	Minimum Stock Diameter (in.)	Minimum Contact Width (in.)	Minimum Stock Diameter (in.)	Minimum Contact Width (in.)
EN30	0.50	1.00	0.57	1.38
EN60	0.62	1.38	0.88	1.88
EN90	0.75	1.75	1.06	2.38
EN120	0.88	1.88	1.25	2.50
EN150	1.00	2.00	1.38	2.88
EN180	1.12	2.13	1.63	3.00
EN240	1.25	2.63	1.63	3.75
EN280	1.25	3.00	1.88	4.25
EN360	1.50	3.25	2.00	4.50
EN460	1.62	3.75	2.38	5.25
EN600	2.00	4.00	2.75	5.63
EN800	2.13	4.63	3.00	6.50
EN900	2.25	5.00	3.25	7.00
EN1000	2.50	5.25	3.50	7.38
EN1100	2.62	5.5	3.75	8.00

** For hardware connected to the body of Eye/Eye Tuflex Roundslings, use the double part columns.

For Temperature and Chemical Information refer to the *Environmental Consideration* page in the WEB section of this catalog.

DIRECT CONNECT HOOKS

Direct Connect hooks are the quickest and easiest way to add hooks to *Tuflex* roundslings and web slings at your job site. No tools or extra parts are needed.

For *Tuflex* slings, just match the color-coded hook to the same color *Tuflex* sling, and you're ready to go. Rated capacities are the same for both the hook and the *Tuflex* roundsling.

Features and Benefits

- Rugged: The alloy steel hook and latch are forged for superior toughness.
- Color-coded hook matches *Tuflex* color and capacity.
- Web-Trap design keeps sling in place, ready to use.
- Four hook sizes to match *Tuflex* sizes EN30 (Purple), EN60 (Green), EN90 (Yellow) and EN150 (Red).
- Can be used with 1" and 2" web slings.
- Quick connections with no tools needed.
- Increases the life of the sling by reducing wear at the bearing point.

Part No.*	Color	Rated Capacity (lbs.)	Tuflex	Web Slings		A (in.)	B (in.)	C (in.)	D (in.)	E (in.)	F (in.)	G (in.)	H (in.)	I (in.)	J (in.)	K (in.)	Weight (lbs.)
				Width	Plies												
DCH1	Purple	2,600	EN30	1	1	3.38	1.56	0.91	4.84	0.47	0.81	.67	3.07	1.22	0.70	1.13	1.54
DCH2	Green	5,300	EN60	1	2	4.00	1.75	1.28	5.83	0.75	1.07	.83	3.58	1.57	0.88	1.39	2.65
DCH3	Yellow	8,400	EN90	2	1 & 2	4.63	2.13	1.40	6.89	0.83	1.26	.98	4.45	1.97	1.00	1.76	4.85
DCH4	Red	13,200	EN150	—	—	5.75	2.34	1.83	8.78	1.63	1.60	1.42	5.21	2.34	1.23	2.21	9.90

* Add an 'L' to end of part number to order replacement latch.

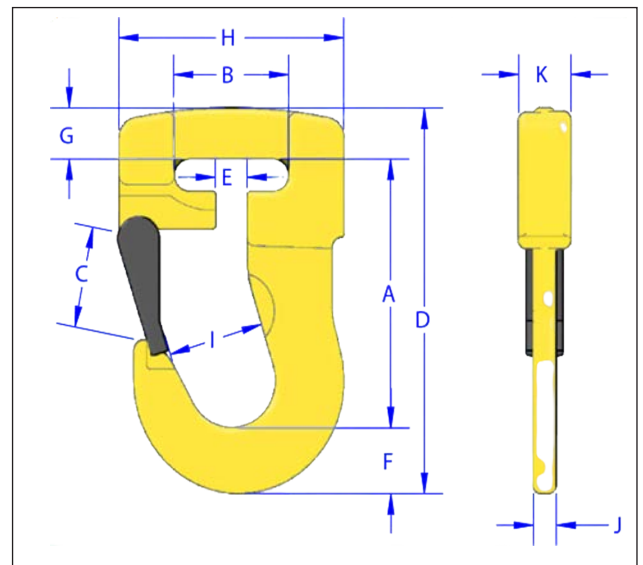

TUFLEX ENDLESS ROUNDSLINGS

The Most Versatile *Tuflex* Roundsling

Features and Benefits

Maintains all the basic *Tuflex* features plus...

Promotes Safety

- Load stability and balance can be achieved by spreading sling legs.

Saves Money

- Wear points can be shifted to extend sling life.
- The most flexible style of sling.
- Individual slings can be attached together using appropriate hardware (see photo).



How To Measure

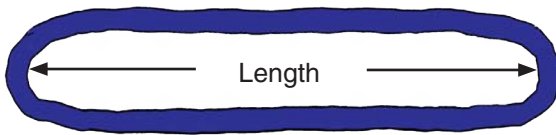

Round Slings

TUFLEX Endless Roundslings											
Part Number	Color	Rated Capacity* (lbs.)				Minimum Length (ft.)	Approximate Measurements				
		Vertical	Choker	Basket @ 90°	Basket @ 45°		Weight (lbs.) (ft.)	Body Diameter Relaxed (in.)	Body Width @ Load (W)(in.)	Minimum Hardware Dia.** (in.)	
EN30	Purple	2,600	2,100	5,200	3,600	1.5	0.20	0.63	1.00	0.44	
EN60	Green	5,300	4,200	10,600	7,400	1.5	0.30	0.88	1.38	0.63	
EN90	Yellow	8,400	6,700	16,800	11,800	3.0	0.52	1.13	1.75	0.75	
EN120	Tan	10,600	8,500	21,200	14,000	3.0	0.60	1.13	1.88	0.88	
EN150	Red	13,200	10,600	26,400	18,000	3.0	0.76	1.38	2.00	1.00	
EN180	White	16,800	13,400	33,600	23,000	3.0	0.87	1.38	2.13	1.13	
EN240	Blue	21,200	17,000	42,400	29,000	3.0	1.10	1.75	2.63	1.19	
EN280	Orange	25,000	20,000	50,000	35,000	3.0	1.25	1.87	3.00	1.25	
EN360	Gray	31,000	24,800	62,000	43,000	3.0	1.70	2.25	3.25	1.50	
EN460	Orange	40,000	32,000	80,000	56,000	3.0	2.30	2.50	3.75	1.62	
EN600	Brown	53,000	42,400	106,000	74,000	8.0	2.90	2.75	4.00	2.00	
EN800	Olive	66,000	52,800	132,000	93,000	8.0	3.40	3.13	4.63	2.13	
EN900	Orange	77,000	61,600	154,000	108,000	8.0	3.90	3.42	5.00	2.25	
EN1000	Black	90,000	72,000	180,000	127,000	8.0	4.40	3.63	5.25	2.50	
EN1100	Orange	100,000	80,000	200,000	140,000	8.0	4.80	4.10	5.50	2.62	

** This is the minimum recommended diameter for the connection hardware to be used for a vertical hitch.

* **WARNING** Always protect Roundslings from corners, edges, or protrusions. Refer to the Sling Protection section of this catalog to choose the right protection product for your lift.

TUFLEX EYE AND EYE

A More Rugged and Durable *Tuflex* Roundsling

The Eye and Eye Advantage

An additional jacket of texturized, abrasion resistant nylon covers the *Tuflex* body forming two color-coded lifting eyes.

Maintains all the basic *Tuflex* features plus...

- Saves money by extending sling life in abrasive environments.

How To Measure

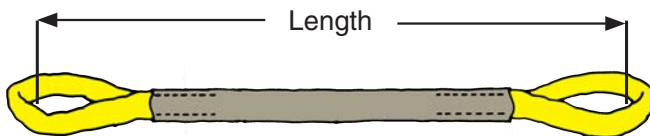

Round Slings

TUFLEX Eye/Eye Roundslings

Part Number	Eye Color	Rated Capacity (lbs.)*				Minimum Length* (ft.)	Approximate Measurements			
		Vertical	Choker	Basket @ 90°	Basket @ 45°		Weight (lbs./ft.) (ft.)	Body Width @ Load (W) (in.)	Standard Eye Length* (EL) (in.)	Minimum Hardware Dia** (in.)
EE30	Purple	2,600	2,100	5,200	3,600	4	0.25	2.25	10	0.44
EE60	Green	5,300	4,200	10,600	7,400	4	0.35	2.50	10	0.63
EE90	Yellow	8,400	6,700	16,800	11,800	4	0.55	2.50	12	0.75
EE120	Tan	10,600	8,500	21,200	14,000	5	0.66	3.50	12	0.88
EE150	Red	13,200	10,600	26,400	18,000	5	0.81	3.50	14	1.00
EE180	White	16,800	13,400	33,600	23,000	7	0.93	3.50	16	1.13
EE240	Blue	21,200	17,000	42,400	29,000	7	1.20	3.50	16	1.19
EE280	Orange	25,000	20,000	50,000	35,000	7	1.30	4.25	18	1.25
EE360	Gray	31,000	24,800	62,000	43,000	7	1.75	4.50	20	1.50
EE460	Orange	40,000	32,000	80,000	56,000	7	2.35	6.00	22	1.62
EE600	Brown	53,000	42,400	106,000	74,000	8	2.90	7.00	24	2.00
EE800	Olive	66,000	52,800	132,000	93,000	10	3.45	8.00	30	2.13
EE900	Orange	77,000	61,600	154,000	108,000	10	3.95	8.00	32	2.25
EE1000	Black	90,000	72,000	180,000	127,000	12	4.45	9.00	36	2.50
EE1100	Orange	100,000	80,000	200,000	140,000	12	4.85	9.00	36	2.62

** This is the minimum recommended diameter for the connection hardware to be used for a vertical hitch.

+ Shorter lengths available using reduced eye lengths.

* **WARNING** Always protect Roundslings from corners, edges, or protrusions. Refer to the Sling Protection section of this catalog to choose the right protection product for your lift.

TUFLEX BRIDLE ROUNDSLINGS

Features and Benefits

Promotes Safety

- Bridle slings provide better load control and balance.
- Use of hardware prevents cutting and abrasion of sling at bearing points.

Saves Money

- Reduces damage by protecting load between pick-up point and crane hook.

Saves Time

- Lightweight and pliable for easy rigging and storage.
- Sling hooks quickly connect to loads having hoist rings or eye bolts.

How to Order

Specify:

1. Number of legs:
S (Single), D (Double), T (Triple), Q (Quad)
2. Master Link: O (Oblong)
3. Bottom Attachments: S (Sling Hook), O (Oblong)
4. *Tuflex* Code: EN30, EN90, etc.
5. Length of Assembly - Feet
(Bearing point to bearing point)

Example:

DOSEN90 X 10' is a double leg bridle, with an oblong master link at the top, and sling hooks on each leg of the *Tuflex* EN90. Overall assembly length is 10-ft.

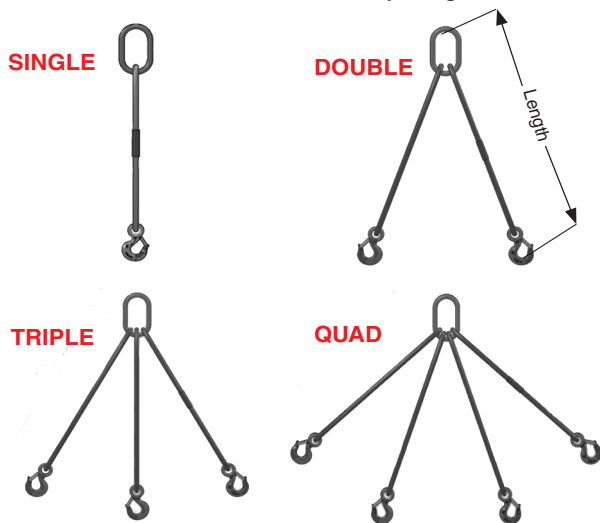

*Find hardware dimensions in Hardware section of this catalog. Use sling leg calculator to determine length @ www.lift-all.com

Note: Import hook with latch is standard. Domestic Hook/latch options upon request.

LEGS	<i>Tuflex</i> Size	Rated Capacity (lbs.)			Hardware*	
		Vertical	Choker	Basket	Hook	Masterlink Stock Dia. (in.)
SINGLE	EN30	2,600	2,100	5,200	2TA	1/2
	EN60	5,300	4,200	10,600	4.5TA	3/4
	EN90	8,400	6,700	16,800	7TA	3/4
	EN120	10,600	8,500	21,200	11TA	1
	EN150	13,200	10,600	26,400	11TA	1
	EN180	16,800	13,400	33,600	15TA	1-1/8
	EN240	21,200	17,000	42,400	22TA	1-1/4
	EN360	31,000	24,800	62,000	20TC	1-1/2
	EN600	53,000	42,400	106,000	30TC	2
	EN800	66,000	52,800	132,000	40TC	2-1/4
EN1000	90,000	72,000	180,000	n/a	2-1/2	

LEGS	<i>Tuflex</i> Size	One Leg @ 90°	ALL Legs @			Hardware*	
			60°	45°	30°	Hook	Masterlink Stock Dia. (in.)
DOUBLE	EN30	2,600	4,500	3,600	2,600	2TA	1/2
	EN60	5,300	9,100	7,400	5,300	4.5TA	3/4
	EN90	8,400	14,500	11,800	8,400	7TA	1
	EN120	10,600	18,300	14,900	10,600	11TA	1-1/4
	EN150	13,200	22,800	18,600	13,200	11TA	1-1/4
	EN180	16,800	29,100	23,700	16,800	15TA	1-1/2
	EN240	21,200	36,700	29,900	21,200	22TA	1-1/2
	EN360	31,000	53,700	43,800	31,000	20TC	2
	EN600	53,000	91,800	74,900	53,000	30TC	2-1/2
	EN800	66,000	114,300	93,300	66,000	40TC	3
EN1000	90,000	155,800	127,200	90,000	n/a	3-1/4	

TRIPLE	EN30	2,600	6,700	5,500	3,900	2TA	3/4
	EN60	5,300	13,700	11,200	7,900	4.5TA	1
	EN90	8,400	21,800	17,800	12,600	7TA	1-1/4
	EN120	10,600	27,500	22,400	15,900	11TA	1-1/2
	EN150	13,200	34,200	27,900	19,800	11TA	1-1/2
	EN180	16,800	43,600	35,600	25,200	15TA	1-3/4
	EN240	21,200	55,000	44,900	31,800	22TA	2
	EN360	31,000	80,500	65,700	46,500	20TC	2-1/4
	EN600	53,000	137,600	112,400	75,900	30TC	3-1/4
	EN800	66,000	171,400	139,900	99,000	40TC	3-1/2
EN1000	90,000	233,800	190,800	135,000	n/a	4-1/4	

QUAD	EN30	2,600	9,000	7,300	5,200	2TA	3/4
	EN60	5,300	18,300	14,900	10,600	4.5TA	1-1/4
	EN90	8,400	29,100	23,700	16,800	7TA	1-1/2
	EN120	10,600	36,700	29,900	21,200	11TA	1-1/2
	EN150	13,200	45,700	37,300	26,400	11TA	1-3/4
	EN180	16,800	58,200	47,500	33,600	15TA	2
	EN240	21,200	73,400	59,900	42,400	22TA	2-1/4
	EN360	31,000	107,300	87,600	62,000	20TC	2-3/4
	EN600	53,000	183,600	149,900	106,000	30TC	3-1/2
	EN800	66,000	228,600	186,600	132,000	40TC	4-1/4
EN1000	90,000	311,700	254,500	180,000	n/a	4-3/4	

BRAIDED TUFLEX ROUNDSLINGS

For multi-part heavy lifting, braided *Tuflex* roundslings offer you additional security.

Safety Built-In

Tuflex braids are made from three (6-Part), or four (8-Part) individual *Tuflex* roundslings. Should one of these component slings be damaged while in use, the remaining undamaged slings will be able to assist in safely returning the load to the ground.

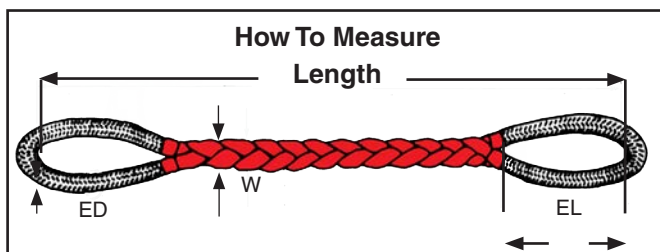

Features and Benefits

Maintains all the basic *Tuflex* features plus ...

Promotes Safety

- Braided construction offers engineered safety.
- Lightweight and more flexible than chain slings.

Saves Money

- Large capacity slings are generally purchased for one major lift, then rarely used again. Braided *Tuflex* roundslings can be returned to *Lift-All* for disassembly, inspection, and re-tagging as individual slings.
- 6-Part flat braid offers wide-body for load stability.

Saves Time

- Easy to transport and hook-up.

Round Slings

6-PART Flat Braid (B6E)

Part Number	Color	Rated Capacity (lbs.)*				Min. Sling Length [†] (ft.)	Approximate Measurements						
		Vertical	Choker	Basket	Basket @ 45°		Wgt. (lbs. per foot)	Standard Eye Length (EL) (in.)	Width @ Load (W) (in.)	Thick-ness at Load (in.)	Eye Dia. (ED) (in.)	Minimum Hardware Dia.** (in.)	Minimum Contact Width (in.)
B6E30	Purple	6,700	5,300	13,400	9,400	4.50	0.8	15	3.25	0.75	1.75	0.63	0.313
B6E60	Green	13,500	10,800	27,000	19,000	5.00	1.2	15	3.75	1.13	2.00	1.00	0.438
B6E90	Yellow	21,400	17,100	42,800	30,000	5.50	1.6	15	4.25	1.25	2.00	1.25	0.500
B6E120	Tan	27,000	21,600	54,000	38,000	5.50	2.0	15	4.50	1.31	2.25	1.38	0.625
B6E150	Red	33,600	26,800	67,200	47,000	6.50	2.7	20	5.25	1.75	2.50	1.50	0.688
B6E180	White	42,800	34,200	85,600	60,000	7.00	3.2	20	5.50	2.00	2.75	1.75	0.813
B6E240	Blue	54,000	43,200	108,000	76,000	9.00	4.4	20	6.63	2.25	3.50	1.75	0.813
B6E360	Gray	79,000	63,200	158,000	111,000	9.50	6.5	30	8.25	2.50	4.25	2.50	1.00
B6E600	Brown	135,100	108,000	270,200	191,000	10.50	9.7	30	11.00	2.75	5.00	3.00	1.313
B6E800	Olive	168,300	134,600	336,600	230,000	13.00	12.0	30	12.00	4.00	5.25	3.50	1.375
B6E1000	Black	229,500	183,600	459,000	320,000	14.50	15.6	31	13.50	4.50	5.75	4.00	1.750

** This is the minimum recommended diameter for the connection hardware to be used for a vertical hitch.

† Shorter lengths available using reduced eye lengths.

* **WARNING** Always protect Roundslings from corners, edges, or protrusions. Refer to the Sling Protection section of this catalog to choose the right protection product for your lift.

BRAIDED *TUFLEX* ROUND SLINGS

Round Slings



Order Information





Ordering length should be based on the sling at rest. Braided *Tuflex* length tolerance is $\pm 2'' + 5\%$ of the ordered length, with the sling at rest. At its rated capacity, braided *Tuflex* will stretch approximately 9%.

Always protect synthetic slings from being cut or damaged on corners, edges and protrusions by using protection sufficient for each application.



Refer to Sling Protection section in this catalog.

8-PART Round Braid (B8E)

Part Number	Color	Rated Capacity (lbs.)*				Min. Sling Length ⁺ (ft.)	Approximate Measurements						
		Vertical	Choker	Basket	Basket @ 45°		Wgt. (lbs. per foot)	Standard Eye Length (EL) (in.)	Width @ Load (W) (in.)	Thick-ness at Load (in.)	Eye Dia. (ED) (in.)	Minimum Hardware Dia. ** (in.)	Minimum Contact Width (in.)
													
B8E30	Purple	8,800	7,100	17,600	12,400	4.50	1.1	15	3.50	1.00	1.75	0.75	0.313
B8E60	Green	18,000	14,400	36,000	25,000	5.00	1.5	15	4.00	1.38	2.00	1.13	0.500
B8E90	Yellow	28,500	22,800	57,000	40,000	5.50	2.2	15	4.75	1.63	2.50	1.50	0.563
B8E120	Tan	36,000	28,800	72,000	50,000	5.50	2.6	15	5.00	1.75	2.50	1.50	0.688
B8E150	Red	44,900	35,900	89,800	63,000	6.50	3.6	20	6.00	2.13	2.75	1.75	0.750
B8E180	White	57,100	45,600	114,200	80,000	7.00	4.1	20	6.25	2.50	3.25	2.00	0.875
B8E240	Blue	72,000	57,600	144,000	101,000	9.00	5.6	20	7.50	2.75	3.75	2.00	0.938
B8E360	Gray	105,400	84,300	210,800	149,000	9.50	8.3	30	9.50	3.25	4.50	2.50	1.125
B8E600	Brown	180,200	144,100	360,400	250,000	10.50	12.0	30	13.00	3.75	5.50	3.50	1.500
B8E800	Olive	224,400	179,500	448,800	310,000	13.00	16.0	30	13.50	4.50	6.00	4.00	1.625
B8E1000	Black	306,000	244,000	612,000	430,000	14.50	20.0	31	15.75	5.25	6.50	4.75	2.00

** This is the minimum recommended diameter for the connection hardware to be used for a vertical hitch.

+ Shorter lengths available using reduced eye lengths.

*** WARNING**

Always protect Roundslings from corners, edges, or protrusions. Refer to the Sling Protection section of this catalog to choose the right protection product for your lift.

HIGH PERFORMANCE ROUNDSLINGS

The solution for lifting the heaviest loads using the lightest, most flexible and ergonomic slings available!

Promotes Safety

- Lift-All slings with high performance core fibers have the lightest sling weight to lifting capacity ratio of our entire product line.
- Non-blended core fibers provide more consistent sling performance.
- Low stretch (1%) is especially helpful when working in low headroom areas.
- Double-wall *Tuffhide* jacket is abrasion resistant, protecting the core fibers from wear and degradation from UV light.
- Flexible, conforms to the shape of load.
- Consistent matched lengths for better multiple sling control.
- *Tuff-Tag* provides serial numbered identification for traceability of manufacturing components and process.
- Endless style allows spreading of sling components, promoting improved load stability.
- Lift-All maintains the same design criteria for the entire product line, and does not lower design requirements for roundslings rated above 100,000 lbs.

Inspection Criteria

Remove from service when:

- Cuts to sling cover expose gold core yarns.
- Holes, tears, snags or abrasion expose gold core yarns.
- The sling shows signs of melting, charring or chemical damage.
- Capacity tag is illegible or missing.
- Other visible damage that causes doubt as to strength of the sling.

Environmental Considerations

- **Chemical:** Do not use in a non-compatible chemical environment. For confirmation, contact *Lift-All* and provide specific chemical, concentration, temperature, and time factors.

Temperature

- **KeyFlex** slings are approved for use up to 350°F.
- **DynaFlex** slings are approved for use up to 158°F.

Saves Time

- Independent core yarns choke tightly, but release easily after use.
- The single component round body profile makes for faster rigging, avoiding any need to keep the sling body flat.
- Round bearing surface makes for easier hook-up to connection point.
- Smaller diameter fits more easily into tight work areas.

Saves Money

- Lightweight construction with high capacity affords an ergonomic solution which reduces rigger fatigue and injury.
- Roundslings with damaged outer covers may be returned for inspection and possible cover repair and proof-test.
- Double-wall seamless cover has no sewn edges preventing rupture, which requires removal from service.
- Wear points can be shifted to extend sling life.

Ordering Information

How to Measure

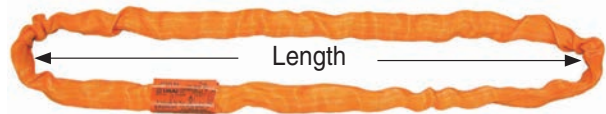

Specify the sling code and length in feet (bearing point to bearing point).

Slings are made to a tolerance of $\pm 1''+1\%$ of the specified length, and can stretch 1% at rated capacity.

Notes:

1. Matched lengths of slings must be specified at time of order.
2. Available in endless style only.

* **WARNING**

Always protect Roundslings from corners, edges, or protrusions. Refer to the Sling Protection section of this catalog to choose the right protection product for your lift.

DYNAFLEX™ ROUNDSLING

Dyneema® High Performance Core Ultra-Lightweight Roundsling

DynaFlex is manufactured with a load bearing core of *Dyneema*®, the world's strongest fiber, yet remains soft and flexible to allow for easy rigging. This high capacity, ultra-lightweight roundsling is a safe and ergonomic alternative to steel and other forms of synthetic slings.



Features and Benefits

- **Ultra-Lightweight** – Approximately 20% lighter than *KeyFlex*™ and 52% lighter than *Tuflex*® for the same capacity, reducing the probabilities of hand and shoulder strains and sprains.
- **Good Chemical Resistance with Reduced Water Absorption** – A 10' *DynaFlex* sling will increase 6 pounds in water weight when rigged wet vs. 13 pounds for the same capacity and length *Tuflex* roundsling. Users will appreciate the weight reduction, minimizing rigger fatigue and increasing safety.
- **Neutral Buoyancy** – *DynaFlex* slings are a great choice for water recovery and lifting applications.
- **100% Dyneema Core (non-blended)** – We use the most advanced high tenacity fiber on the market for lifting slings. The homogeneous core fiber reacts uniformly regardless of lift application. Designed with your safety in mind.
- ***DynaFlex* Single Component Twisted Core** – Single path design allows higher strength retention around common rigging hardware. This saves time during hook up to the connection point and rigging vs. dual path slings. No need to worry about sling body orientation.
- **Promotes Safety** – Customized designs are available, including higher capacity and/or shorter length versions.

Note: *DynaFlex* slings are approved for use up to 158°F.

*  **WARNING**

Always protect Roundslings from corners, edges, or protrusions. Refer to the Sling Protection section of this catalog to choose the right protection product for your lift.

High Performance Roundslings



DYNAFLEX™ ROUNDSLING

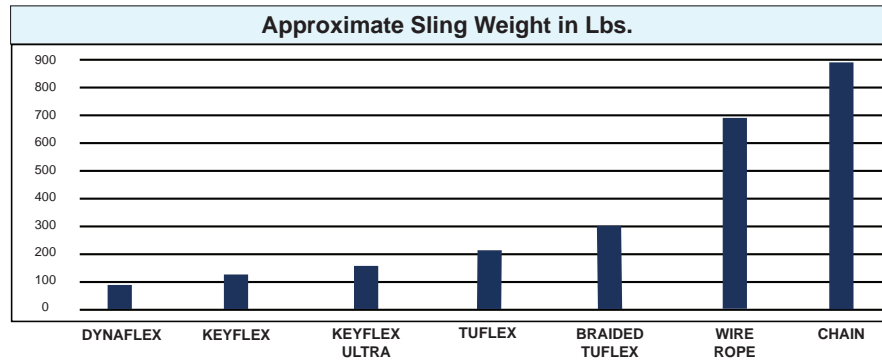
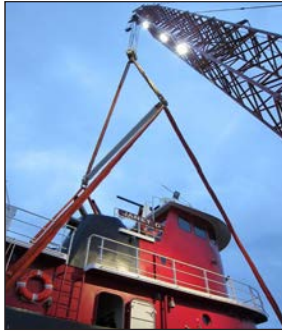

Round Slings

Item	Approximate Sling Weight (lbs.)	Vertical Capacity (lbs.)
<i>DynaFlex</i> RoundSling: DEN200K x 25-ft.	99	200,000
<i>KeyFlex</i> RoundSling: KEN200K x 25-ft.	130	200,000
<i>KeyFlex Ultra</i> RoundSling: KEN3P200 x 25-ft.	173	200,000
<i>Tuflex</i> RoundSling (2 ea.): EN1000 x 25-ft.	207	180,000
<i>Braided Tuflex</i> RoundSling: B8E600 x 25-ft.	300	180,000
Wire Rope Sling (2 ea.): 2-1/4" 6X37 IWRC x 25-ft.	669	176,000
Chain Sling (2 ea.): 1-1/4" SOS x 25-ft.	870	144,600

DynaFlex Capacities and Measurements

Part Number	Rated Capacity (lbs.)				Min. Length (ft.)	Approximate Measurements				
	Vertical	Choker	Basket @ 90°	Basket @ 45°		Wgt. (lbs per foot)	Body Dia. Relaxed (in.)	Width @ Load (in.)	Minimum Hardware Diameter (in.)	Minimum Contact Width (in.)
DEN10K	10,000	8,000	20,000	14,100	3	0.25	1.00	1.56	0.69	0.23
DEN15K	15,000	12,000	30,000	21,000	3	0.38	1.13	1.75	0.88	0.31
DEN20K	20,000	16,000	40,000	28,000	3	0.44	1.25	2.00	1.06	0.37
DEN25K	25,000	20,000	50,000	35,000	3	0.54	1.25	2.13	1.25	0.47
DEN30K	30,000	24,000	60,000	42,000	3	0.66	1.38	2.13	1.44	0.50
DEN40K	40,000	32,000	80,000	56,000	3	0.79	1.75	2.75	1.50	0.53
DEN50K	50,000	40,000	100,000	70,000	5	1.16	1.88	2.88	1.75	0.62
DEN60K	60,000	48,000	120,000	84,000	5	1.31	2.00	3.13	2.00	0.69
DEN70K	70,000	56,000	140,000	98,000	8	1.47	2.13	3.25	2.19	0.76
DEN80K	80,000	64,000	160,000	113,000	8	1.59	2.25	3.50	2.38	0.82
DEN90K	90,000	72,000	180,000	127,000	8	1.94	2.50	3.88	2.38	0.83
DEN100K	100,000	80,000	200,000	141,000	8	2.06	2.75	4.25	2.50	0.84
DEN125K	125,000	100,000	250,000	176,000	8	2.60	3.00	4.88	2.63	0.92
DEN150K	150,000	120,000	300,000	210,000	8	3.24	3.25	5.25	2.88	1.00
DEN175K	175,000	140,000	350,000	240,000	8	3.51	3.50	5.75	3.13	1.10
DEN200K	200,000	160,000	400,000	280,000	8	3.90	3.75	6.13	3.38	1.18

* **WARNING** Always protect Roundslings from corners, edges, or protrusions. Refer to the Sling Protection section of this catalog to choose the right protection product for your lift.

KeyFlex roundslings with *Technora*® core are light and flexible

The chart at the right plots the weights of 20-ft. slings at various capacities:

Sling Type	Vertical Rating (lbs.)	Sling Weight (lbs.)
<i>KeyFlex</i>	90,000	48
<i>Tuflex</i>	90,000	86
Wire Rope	88,000	357
Chain	72,300	358

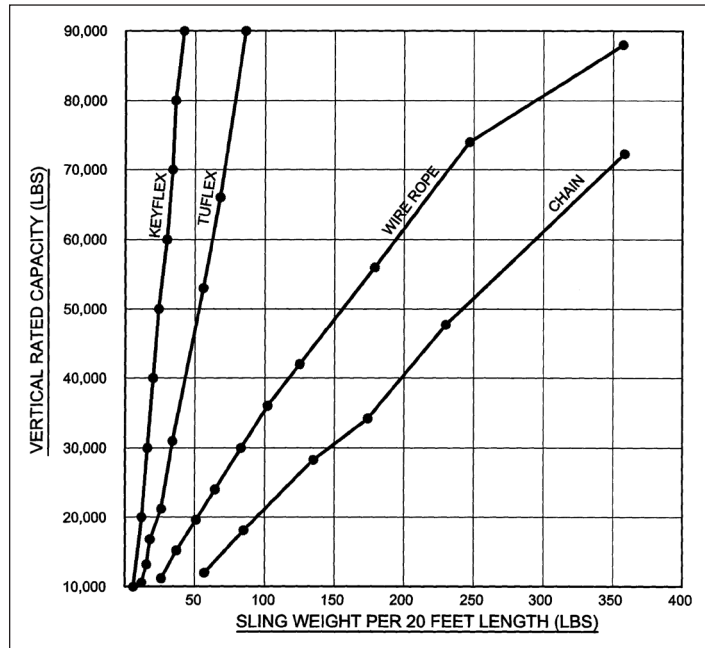

KeyFlex Benefits:

- Low weight per capacity reduces risk of injury to riggers.
- 1% stretch at rated capacity reduces abrasion and allows for better load control.
- Great for low headroom situations.
- *KeyFlex* with aramid load fiber are approved for use **up to 350°F**.
- Lightweight and compact size promotes speedier rigging, transport and storage when compared to any other type of sling.

KeyFlex Capacities and Measurements

Part Number	Rated Capacity (lbs.)				Min. Length (ft.)	Approximate Measurements				
	Vertical	Choker	Basket @ 90°	Basket @ 45°		Wgt. (lbs per foot)	Body Dia. Relaxed (in.)	Width @ Load (in.)	Minimum Hardware Diameter (in.)	Minimum Contact Width (in.)
KEN10K	10,000	8,000	20,000	14,100	3	0.3	1.00	1.56	0.69	0.23
KEN15K	15,000	12,000	30,000	21,000	3	0.5	1.13	1.75	0.88	0.31
KEN20K	20,000	16,000	40,000	28,000	3	0.6	1.25	2.00	1.06	0.37
KEN25K	25,000	20,000	50,000	35,000	3	0.7	1.25	2.13	1.25	0.47
KEN30K	30,000	24,000	60,000	42,000	3	0.8	1.38	2.13	1.44	0.50
KEN40K	40,000	32,000	80,000	56,000	3	1.0	1.75	2.75	1.50	0.53
KEN50K	50,000	40,000	100,000	70,000	5	1.3	1.88	2.88	1.75	0.62
KEN60K	60,000	48,000	120,000	84,000	5	1.7	2.00	3.13	2.00	0.69
KEN70K	70,000	56,000	140,000	98,000	8	1.9	2.13	3.25	2.19	0.76
KEN80K	80,000	64,000	160,000	113,000	8	2.1	2.25	3.50	2.38	0.82
KEN90K	90,000	72,000	180,000	127,000	8	2.4	2.50	3.88	2.38	0.83
KEN100K	100,000	80,000	200,000	141,000	8	2.6	2.75	4.25	2.50	0.84
KEN125K	125,000	100,000	250,000	176,000	8	3.0	3.00	4.88	2.63	0.92
KEN150K	150,000	120,000	300,000	210,000	8	3.5	3.25	5.25	2.88	1.00
KEN175K	175,000	140,000	350,000	240,000	8	4.8	3.50	5.75	3.13	1.10
KEN200K	200,000	160,000	400,000	280,000	8	5.3	3.75	6.13	3.38	1.18

Available in higher capacity and/or shorter length versions.

Technora® is a registered trademark of Teijin LTD.

* **WARNING**

Always protect Roundslings from corners, edges, or protrusions. Refer to the Sling Protection section of this catalog to choose the right protection product for your lift.

KEYFLEX ULTRA™ ROUNDSLINGS

The Higher Capacity *KeyFlex* Roundslings

- **High Capacities:** Up to 1/2 million pounds in a vertical hitch, or 1 million pounds in a basket hitch.
- **Rugged Construction:** Our best 4-Ply *Tufhide* nylon jacket covers three individual *KeyFlex* roundslings with *Technora*® core.
- **High Value:** You get the *Lift-All* quality you expect which exceeds industry standards at a competitive price.
- **Extra Utility:** *KeyFlex Ultra* roundslings can be returned to *Lift-All* for disassembly, inspection, and re-tagging as individual slings.
- **Repairable:** The outer cover can be replaced .



Round Slings



KeyFlex Ultra is 87% lighter than comparable capacity wire rope slings.

This makes it easier to handle, and safer for workers to use.

Part Number	Rated Capacity (lbs.)			
	Vertical	Choker	Basket @ 90°	Basket @ 45°
KEN3P200	200,000	160,000	400,000	280,000
KEN3P250	250,000	200,000	500,000	350,000
KEN3P300	300,000	240,000	600,000	420,000
KEN3P400	400,000	320,000	800,000	560,000
KEN3P500	500,000	400,000	1,000,000	700,000

Available in lengths up to 79 feet

Part Number	Component Sling Size	Minimum Sling Length (ft.)	Weight Per Foot (lbs.)	Body Diameter Relaxed (in.)	Body Width @ Load (in.)	Minimum Edge Contact Radius	Minimum Hardware Diameter
KEN3P200	KEN80K	10	6.9	3.88	6.25	1.13	3.25
KEN3P250	KEN100K	12	8.6	4.75	7.75	1.25	3.25
KEN3P300	KEN125K	14	9.9	5.50	9.00	1.25	3.50
KEN3P400	KEN150K	15	15.8	6.00	10.50	1.50	4.25
KEN3P500	KEN200K	17	17.5	6.75	11.00	1.63	4.63

Technora® is a registered trademark of Teijin LTD.

* **WARNING**

Always protect Roundslings from corners, edges, or protrusions. Refer to the Sling Protection section of this catalog to choose the right protection product for your lift.

STEELFLEX ROUNDSLINGS

THE STEEL SLING
WITH THE FABRIC FEEL

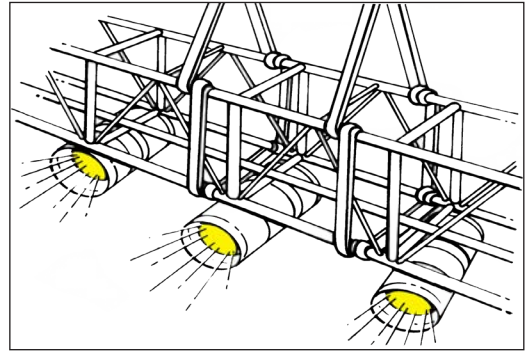

Designed for suspension applications

With safety being of the utmost importance in overhead suspension, *Lift-All's Steelflex* roundslings combine flexibility, strength and heat resistance (400°F) with the soft feel of fabric to meet your most demanding suspension requirements.

Steelflex roundslings feature steel galvanized aircraft cable wound in an endless configuration. This wire core is encased in a black double-wall, polyester jacket. A unique inspection window allows for easy inspection of the core for broken wires and corrosion. The result is a highly flexible, easy to use sling that complies with all of the current rigging codes. Stretch at rated capacity is approximately 1%.

Features and Benefits

- Black cover for stage rigging applications.
- No backup rigging required.
- Window allows complete core inspection.
- Superior flexibility makes rigging easy.
- Conforms to load to grip securely.
- Superior cut resistance.

How To Measure



Part Numbers	Rated Capacity (lbs.)			Minimum Hardware Dia. (in.)
	Vertical	Choker	Basket	
GACEN40X18IN	3,600	3,000	7,200	.625
GACEN40X2				
GACEN60CX18IN	5,300	4,200	10,600	.625
GACEN60CX2				
GACEN60X3				
GACEN60X4				
GACEN60X5				
GACEN60X6				
GACEN60X7				
GACEN60X8				
GACEN60X9				
GACEN60X10				
GACEN60X11				
GACEN60X12				

400°F Temperature Rating
NO Wire Rope Backup Needed
Core Inspection Window Standard





1. Maximum length for *Steelflex* is 12-ft.
2. Sling lengths under 3' use a modified construction and do not have a seamless cover.

POLYESTER STAGE SLINGS

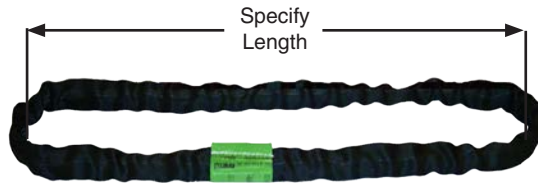
These lightweight roundslings are ideal for easy and inconspicuous suspension of stage sound and lighting equipment. Black sleeve material helps sling blend into the surroundings. *Lift-All* stage slings include the *Tuflex* features and benefits except that the color coding of the slings is achieved by using a color-coded identification tag. Double-wall sleeve material is standard.



Round Slings

Part Number	Rated Capacity (lbs.)*			Minimum Length (ft.)	Approximate Measurements			
	Vertical 	Choker 	Basket 		Weight (lbs. / ft.)	Body Diameter Relaxed (in.)	Body Width @ Load (in.)	Minimum Hardware Diameter (in.)
BSEN30	2,600	2,100	5,200	1-1/2	.2	5/8	1-1/8	7/16
BSEN60	5,300	4,200	10,600	1-1/2	.3	7/8	1-1/2	5/8
BSEN90	8,400	6,700	16,800	3	.4	1-1/8	1-7/8	3/4

TUFLEX WIDE-LIFT

Wide Load Support and Balance

Tuflex wide-lift slings distribute the load over a wide area and offer better balance of larger loads - whether heavy or light.

Features and Benefits

Maintains all the basic *Tuflex* features plus ...

Promotes Safety

- Wide body distributes load over wide area and offers improved stability.

Saves Money

- Bearing point of eyes can be shifted to prolong sling life.
- Custom sizes available to fit your needs.

Saves Time





- Standard eye length is 12", making hook-up easy and fast.
- Standard body width is 12", making load balancing easier.

Note:

Wide-lift slings should only be used in basket hitch.

Consult *Lift-All* for special requirements.



Code	Color of Eyes	Vertical Basket Hitch Rated Capacity* (lbs.)
WLEN30	Purple 	5,200
WLEN60	Green 	10,600
WLEN90	Yellow 	16,800
WLEN120	Tan 	21,200

*  **WARNING** Always protect Roundslings from corners, edges, or protrusions. Refer to the Sling Protection section of this catalog to choose the right protection product for your lift.

ROUNDSLING INSPECTION CRITERIA

The following photos illustrate some of the damage that occurs and indicates the sling must be taken out of service. For inspection frequency requirements, see the General Information section in this catalog.

Round
Slings

CUTS TO THE COVER

WHAT TO LOOK FOR: Broken fibers of equal length indicate that the sling has been cut. When core yarns are exposed, the damage to the yarns cannot be determined. Therefore, the sling must be taken out of service.

TO PREVENT: Always protect synthetic slings from being cut by using cut protection. See Sling Protection section in this catalog.

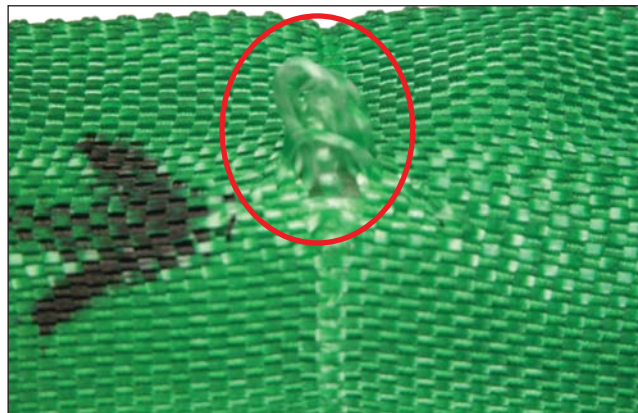
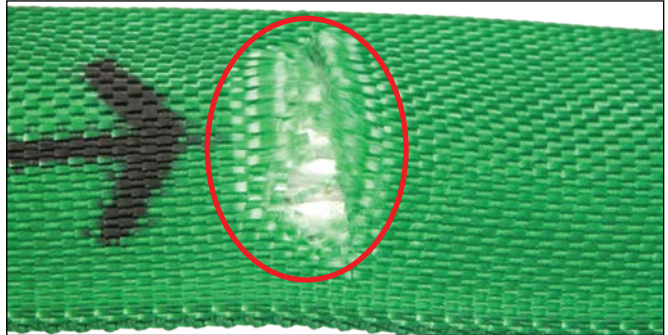

HOLES, SNAGS, or PULLS

WHAT TO LOOK FOR: Punctures or areas where fibers stand out from the rest of the sling surface. Inspect sling and remove from service if core yarn is exposed.

TO PREVENT: Avoid sling contact with protrusions, both during lifts and while transporting or storing. See Sling Protection section in this catalog.

ABRASIVE WEAR

WHAT TO LOOK FOR: Areas of the sling that look and feel fuzzy indicate that the fibers have been broken by contact and movement against a rough surface. Affected areas are usually discolored. Inspect sling and remove from service if core yarn is exposed.

TO PREVENT: Never drag slings along the ground. Never pull slings from under loads that are resting on the sling. Use wear protection between slings and rough surface loads. See Sling Protection section in this catalog.

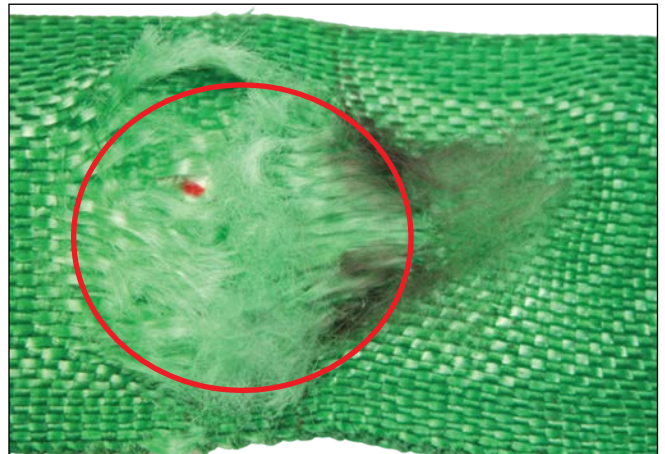

ROUNDSLING INSPECTION CRITERIA

HEAT / CHEMICAL DAMAGE

WHAT TO LOOK FOR: Melted or charred fibers anywhere along the sling. Heat and chemical damage look similar and can damage sling fibers, compromising the sling's strength. Look for discoloration and/or fibers that have been fused together and may feel hard or crunchy. Slings showing heat or chemical damage must be removed from service.

TO PREVENT: Never use *Tuflex* roundslings where they can be exposed to temperatures in excess of 200°F, or around chemicals without confirming that the sling material is compatible with the chemicals being used. For elevated temperatures up to 350°F, use *KeyFlex* roundslings.

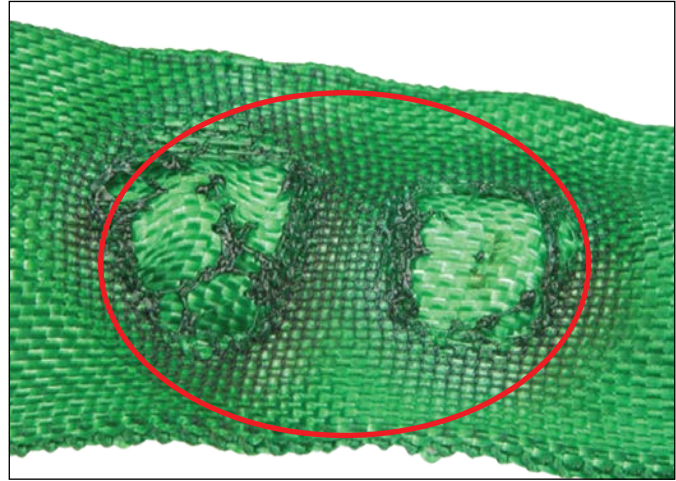

ILLEGIBLE OR MISSING TAGS



WHAT TO LOOK FOR: The information provided on the sling tag is important for knowing what sling to use and how it will function. If you cannot find or read all of the information on a sling tag, the sling must be taken out of service.

TO PREVENT: Never set loads down on top of slings or pull slings from beneath loads if there is any resistance. Load edges should never contact sling tags during the lift. Avoid paint or chemical contact with tags.

KNOTS

WHAT TO LOOK FOR: Knots compromise the strength of slings by not allowing all fibers to contribute to the lift as designed. Knots are rather obvious problems as shown here.

TO PREVENT: Never tie knots in slings.



Cuts to the cover NOT exposing internal core yarns. The double-walled jacket protects the inner core yarns from damage. If the damage appears only to the outer jacket and does not expose the inner core yarns, the sling may remain in service (except chemical or heat damage). The sling may also be returned to *Lift-All* for inspection and repair to the jacket.

TO PREVENT: Use the appropriate sling protection between the sling and all edges that come in contact with the sling. See the Sling Protection section in this catalog.