





SERVICE GUIDE
For
WARN PULLZALL 120Vac
P/N 885000 & 885001

- **REPAIR / REPLACEMENT INSTRUCTIONS**
- **TROUBLE SHOOTING GUIDE**



 **WARNING**

This guide identifies potential hazards and has important safety messages that help you and others avoid personal injury or death. **WARNING** and **CAUTION** are signal words that identify the level of hazard. These signal words mean:

 **WARNING** signals a hazard that may cause serious injury or death, if you do not follow recommendations.  **CAUTION** signals a hazard that may cause minor to moderate injury, if you do not follow recommendations.

This guide uses  **NOTICE** to call attention to important mechanical information, and

Note: to emphasize general information worthy of special attention.

Notice

- This guide has been provided for use by WARN Authorized Service Centers. Any other use is prohibited.

 **Caution**

Moving parts entanglement hazard

Failure to observe these instructions could lead to minor or moderate injury

- **Always** take time to fully read and understand the Instructions.
- **Never** operate this product if you are under 16 years of age.
- **Never** operate this product when under the influence of drugs, alcohol or medications.

Read instructions thoroughly

Notice

Equipment damage

- **Always** refer to the Wiring Diagram for all wiring schematics and specific details on how to wire this **WARN** product.

Read instructions thoroughly.

CONTENTS

1. GENERAL DESCRIPTION	04
2. DISASSEMBLY AND ASSEMBLY	
2.1. Suggested Tools	06
2.2. Housing	07
2.3. Gear Train Assembly	11
2.4. Motor	18
2.5. Wire Rope Assembly	24
2.6. Safety Hook	29
2.7. Tail Hook	33
2.8. Drum Assembly	38
2.9. Wiring Diagrams	39
2.10. Torque Specifications	47
3. PULLZALL TROUBLE SHOOTING	48
4. SERVICE PART LIST	50



1. GENERAL DESCRIPTION

The PullzAll is a powerful, lightweight, easy-to-use handheld electric tool with the ability to lift or pull up to 1,000 lbs / 454 kg. A strong Motor and Variable Speed Trigger Switch for power in and power out operation, Wire Rope and Clasp Hook will allow you to move heavy items into place smoothly and precisely. These features equate to saving both time and money.

The PullzAll will help get the job done easier, faster, and with less manual labor than a come-a-long or chain fall, making you more productive. The PullzAll is for the tradesperson, farmer / rancher, or anyone that needs to lift or pull up to 1,000 lbs / 454 kg. This makes PullzAll ideal for construction, pipe fitting, iron work, equipment and plant maintenance, farm and ranch use, auto shops, garages, machine shops, home improvement, hunting, camping, and more.

PullzAll 120v AC Specifications:

1. Part number 885000.
2. Light weight and portable.
3. Powerful 120 Volt AC Motor.
4. 1,000 lbs (454 kg) lifting / pulling capacity.
5. 15'(4.6m) of 7/32"(0.56cm) diameter Wire Rope.
6. Variable Speed Control for precision load placement.
7. Convenient forward/reverse Switch.
8. Electronic Load Limiter with LED indicator for operator feedback.



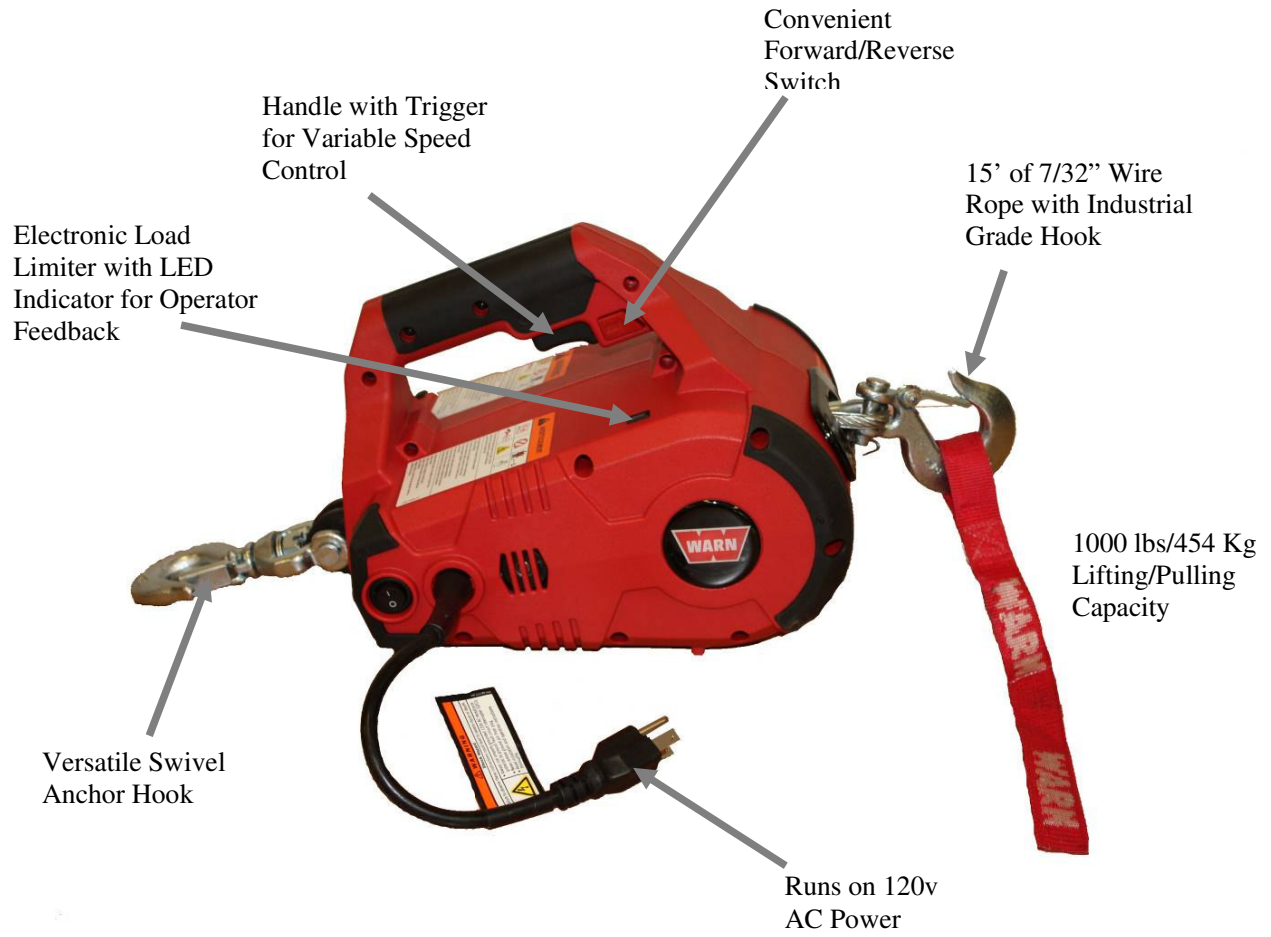

2 DISASSEMBLY AND ASSEMBLY

2.1 SUGGESTED TOOLS

1. Hammer
2. Snap ring plier
3. Allen key set
4. Screw driver
5. Cutting plier
6. Pin remover (Punch)
7. Insulation tape
8. Gloves

2.2 HOUSING

Before opening the Housing follow the below instructions:

Power Cord

Always unplug the product while rigging, when not in use or during maintenance and cleaning.

2.2.1 REMOVAL OF HOUSING

1. Remove the screws (#6 x .75), Qty 7 from Handle.



2. Remove the screws (#8 X 1.25), Qty 6 from the main body of the Housing.



3. Keep the assembly on the work bench facing the Cover in the direction as shown in the figure.



4. Remove the Plastic Housing -left hand from the assembly as shown in the figure.



5. Remove the Main Chassis from the Plastic Housing - right hand and place it on the work bench.



2.2.2 ASSEMBLY OF HOUSING

1. Install the Main Chassis in the Plastic Housing - right hand as shown in the figure.



2. Install the Plastic Housing -left hand on the assembly as shown in the figure.



3. Flip the assembly as show in the figure.



4. Install the screws (#8 X 1.25), Qty 6 from the main body of the Housing.



5. Install the screws (#6 x .75), Qty 7 near Handle.



Note: When replacing the Housings with a Housing Service kit, be sure to affix ALL appropriate labels from the service kit onto the new housings, using the housings being replaced as a guide for placement of your new labels. Your service kit will include extra labels for other languages and markets that can be discarded after you select the ones needed for your product.

2.3 GEAR TRAIN ASSEMBLY

- If the gearsets are worn or damaged, the entire PullzAll must be replaced, no replacement parts are available.

2.3.1 GEAR TRAIN ASSEMBLY REMOVAL

1. Remove Retaining Ring from Idler Gear.



2. Remove Wear Washer from Idler Gear.

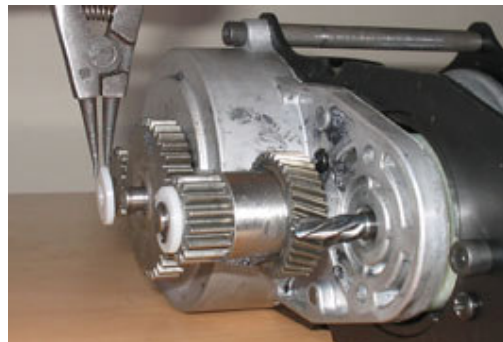

3. Remove Retaining Ring from Helical Gear Press. Remove Wear Washer from Helical Gear.

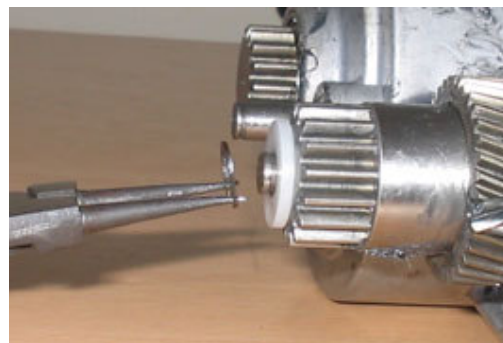

4. Remove Helical Gear from Gear Housing.



5. Remove 3 Cap Screws(#3 x .75) from Gear Housing through Left side Bracket of Chassis assembly.



6. Remove Gear Housing from left side Bracket of Chassis assembly.

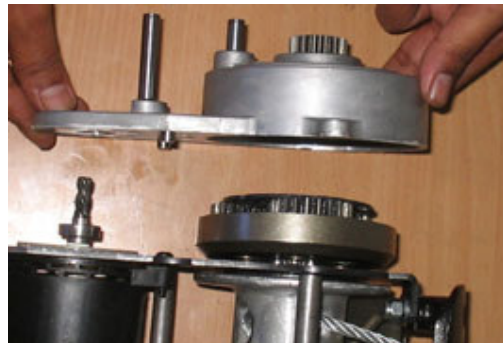

7. Remove Carrier Assembly from Ring.

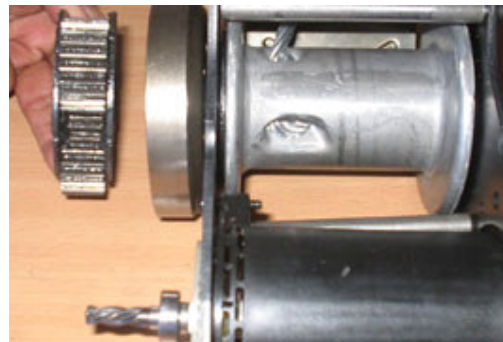

8. Remove Ring Gear 51 T from left side Bracket P/N of Chassis assembly.

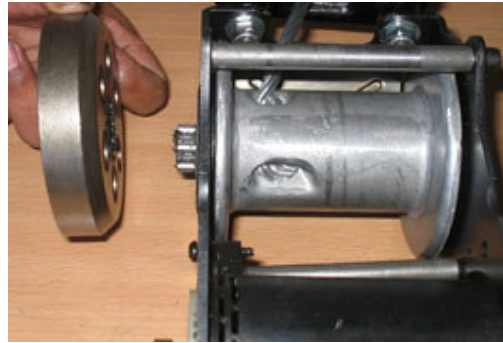

2.3.2 GEAR TRAIN REASSEMBLY

1. Install Gear Train assembly after installation of Motor assembly.

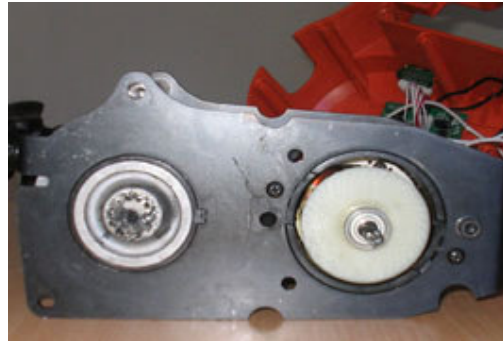

2. Insert Ring Gear 51 T on Left side Bracket of Chassis assembly as shown in the figure.

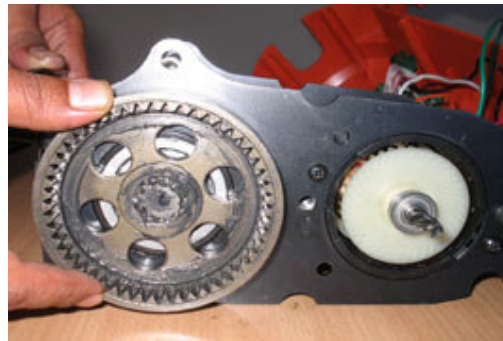

3. Install Ring Gear 48T P/N 73225 and Carrier Assembly P/N 73227 in Gear Housing P/N 75077.



4. Install Gear Housing on Left side Bracket of Chassis assembly aligning dowel pins.

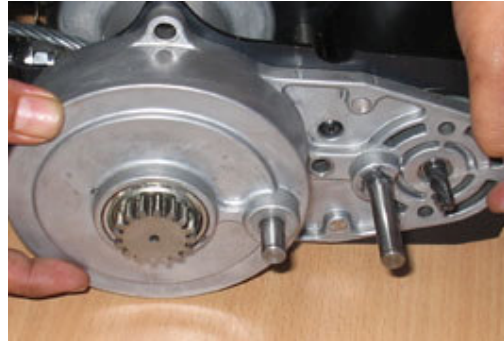

5. Install 3 Cap Screws (#3 x .75) in Gear Housing through Left side Bracket of Chassis assembly.



6. Install Helical Gear on Gear Housing as shown in the figure.



7. Install Wear Washer on Helical Gear Press.



8. Install Retaining on Helical Gear.



9. Install Idler Gear on Gear Housing.



10. Install Wear Washer and Retaining Ring on Idler Gear.



2.3.3 INSPECTION OF GEAR TRAIN

1. Check each Idler Gear to make sure that all teeth are present in good condition.
2. Check each Sun Gear to make sure all teeth are present and in good condition.
3. Check each side of each Sun Gear to make sure there are no grooves from wear. Replace the Gear Set if worn.
4. Check Carrier Assembly to make sure that Planet Gears are tight. Each Gear should be able to move a small distance when pulled from and pushed toward center of Gear Set. All Planet Gears should have about the same amount of movement. Replace Carrier Assembly if Planet Gears are loose.
5. Push each Planet Gear against its axle pin and rotate the Gear completely. The Gear must turn smoothly on Pin. Replace Gear Set if Planet Gears do not turn smoothly.
6. Check the Ring Gear 48T inside the Gear Housing. All the Gear teeth must be in good condition and they must be free of debris. The Gear Housing must be replaced if teeth have a wear groove.
7. If the Gear sets are worn or damaged, the entire PullzAll must be replaced, no replacement Parts are available.



2.4 MOTOR

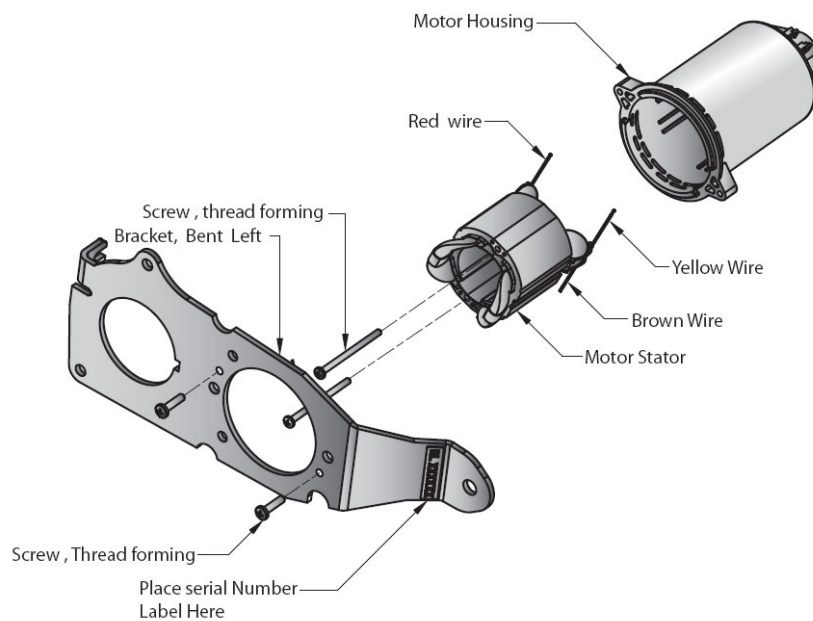
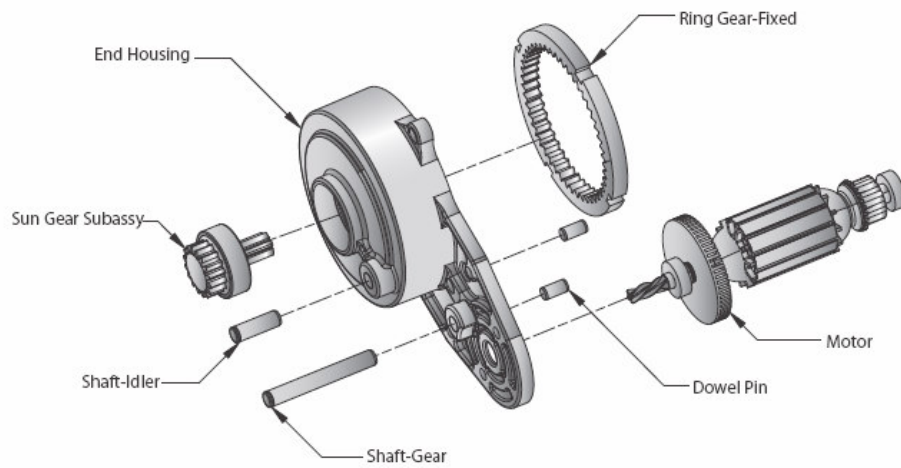

2.4.1 REMOVAL OF MOTOR

Before removing the Motor follow the instructions given below:

1. Remove the Gear Train assembly.

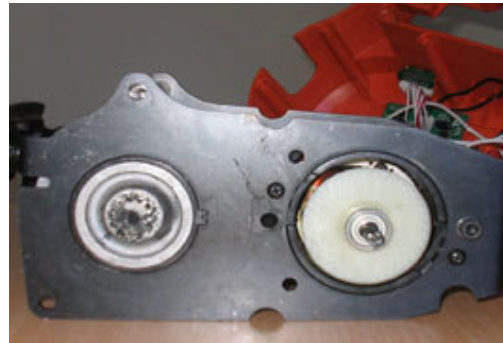

2. Remove the 2 screws (#8 x 0.75) from Chassis assembly.



3. Remove the left side cap screw and nut from Hawse Fairlead assembly.



4. Remove cap screw from Chassis assembly as shown in the figure.



5. Remove Left side Bracket from Chassis assembly.



6. Remove Motor assembly from Chassis assembly after removal of Wiring leads

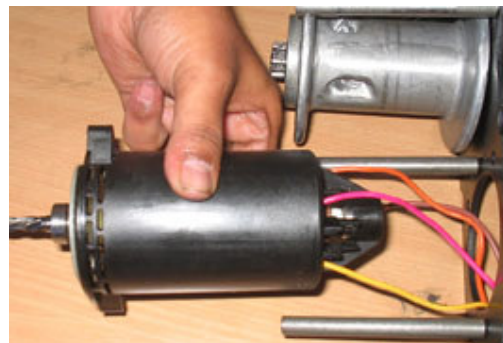

2.4.2 ASSEMBLY OF MOTOR

1. Connect all Wire leads from Motor assembly and install in to Chassis assembly as shown in the figure.



2. Install Left side Bracket on Chassis assembly as shown in the figure.



3. Install cap screw in Chassis assembly as shown in the figure.



4. Install the left side cap screw and nut from Hawse Fairlead assembly.



Install 2 screws (#8 x 0.75) in Chassis assembly.



2.4.3 MOTOR INSPECTION

- Visual inspection.
- While assembling the Motor ensure that, Motor has been properly placed inside the End Housing and the screw had been properly tightened.

2.5 WIRE ROPE ASSEMBLY

2.5.1 REMOVAL OF WIRE ROPE

Note:

Prior to disassembly:

1. Spool out all Wire Rope.
2. Use of gloves is recommended while handling frayed or damaged Wire Rope.
3. Unplug unit before disassembly.

Tasks:

Disassemble the Drum and Wire Rope.

1. Push the Wire in the direction of the arrow mark as shown in the figure.

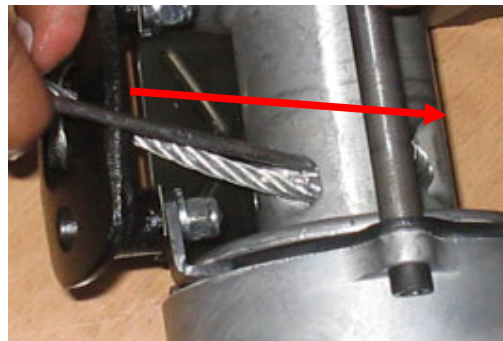

2. Using a punch or drift and hammer, hit the end of the Wire Rope to push the loop back through the Drum.



3. Use the Pin remover (punch) to remove the Wire Rope and Stop Button from the Drum.



4. Straighten the bent Rope and pull the Rope out of Drum hole in the arrow direction as shown.



5. Remove the Hawse Fairlead from the Bracket of the Chassis.

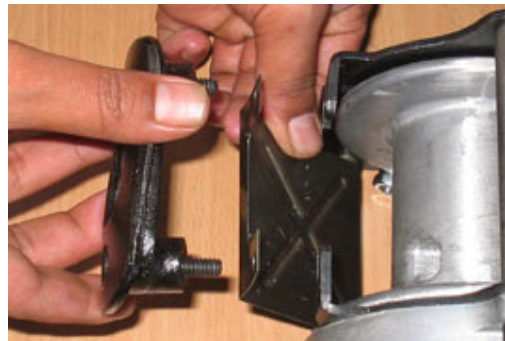

6. Remove and discard Tension Plate (if equipped).



2.5.2 ASSEMBLY OF WIRE ROPE

1. Assemble the Hawse Fairlead to the Bracket of the Chassis.

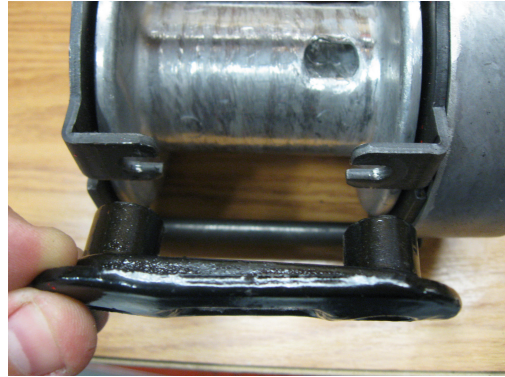

2. Tighten the CapScrews with Allen key and opened end wrench.

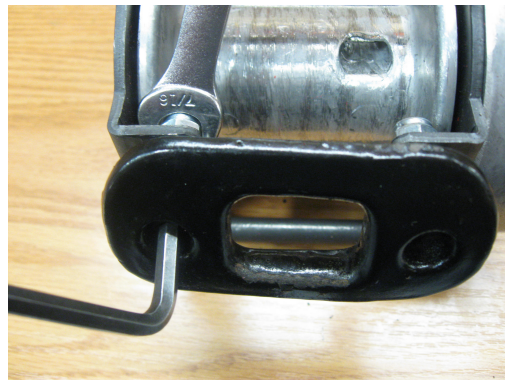

3. Keep the insulation tape to the edge of the Wire Rope.



4. Insert the Wire Rope into the Drum through the Hawse Fairlead.



5. Pull the wire from the other end of the Drum hole.



6. Bend the Wire Rope and insert in to the same hole in the direction shown in the figure.



7. Pull the Wire Rope from the hole as shown in the figure.



8. Support one edge of the Wire and pull the other Wire as shown in the figure.

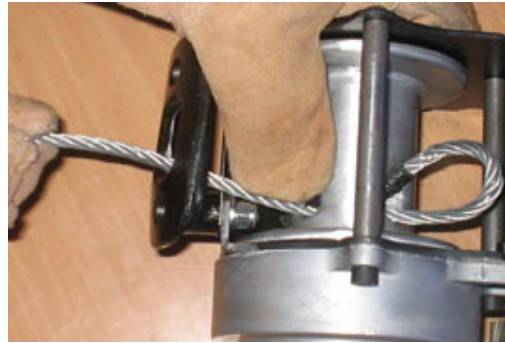

9. Verify Wire Rope stop button is inserted into the loop as shown before pulling the Wire Rope tight.



10. Hit wire rope loop with a hammer, so that the Wire Rope will be pushed in to the rope retention hole.



11. Check the Wire Rope so that it enters completely into the Drum hole.



12. Check from the other side of the Drum whether the Wire Rope is perfectly assembled to the Drum.



2.5.3 INSPECTION OF WIRE ROPE

- Inspect the Wire Rope for signs of wear or damage. Worn and damaged parts must be replaced.
- See the Rope for damage for kinks, cuts, knots, mashed or frayed portions and broken strands.
- Keep the Rope free from contaminants. Use a clean towel to remove the dirt and debris.
- Use of light oil on the Wire Rope can prevent corrosion.

2.6 SAFETY HOOK



2.6.1 REMOVAL OF SAFETY HOOK

To remove Safety Hook follow the below instructions:

1. First straighten the bent end of the Cotter Pin by using Cutting plier and then pull out the Cotter Pin by holding head of the Cotter Pin with the help of cutting plier from the Pin.



2. Remove the Pin from the Hook and Rope.



3. Remove the Safety Hook from Wire Rope



2.6.2 ASSEMBLY OF SAFETY HOOK

To Reassemble Safety Hook follow the below instructions:

1. Place the Safety Hook and align the mounting holes with the loop of the Wire Rope



2. Insert the Pin through Safety Hook and Wire Rope loop.



3. Insert the Cotter Pin inside the hole of the Pin and bend the ends of the Cotter Pin with the help of Cutting pliers.



2.6.3 INSPECTION OF SAFETY HOOK

- Inspect the Hook for signs of wear and damage.
- Hook damage examples: cracks, twisted components, excessive opening, seat wear, loose or damaged safety latch or corrosion.

2.7 TAIL HOOK



Original Tailhook Assy



2nd Generation Tailhook Assy
Service Part Tailhook Assy

2.7.1 REMOVAL OF TAIL HOOK

To remove Tail hook follow the below instructions:

1.Remove bolt and nut from the Chassis assembly through Tail Hook.



2.Loose the cap screw with Allen key before removing the Tail Hook and Spacer Pin from Chassis assembly.



2.7.2 ASSEMBLY OF TAIL HOOK

To reassemble the Original Tailhook follow the below instructions:

1. Tighten the cap screw after place Tail Hook and Spacer Pin between the Bracket holes.



2. Assemble the bolt and nut.



To reassemble the Second Generation Tail Hook follow the instructions:



1. Place Spacer Bracket in Chassis assembly with capscrew and then apply the torque.



2. Take the Tail Hook and align the mounting holes with the Spacer Bracket holes and Chassis assembly.



3. Insert the Pin through the Hook assembly.



4. Insert the Cotter Pin inside the hole of the Pin and bend the ends of the Cotter Pin with the help of pliers.



2.7.3 TAIL HOOK INSPECTION

- Inspect the Hook for signs of wear and damage
- Hook damage examples: cracks, twisted components, excessive opening, seat wear, loose or damaged safety latch or corrosion.

2.8 DRUM ASSEMBLY

- If the drum is worn or damaged, the entire PullzAll must be replaced, no replacement parts are available.



2.9 WIRING DIAGRAMS

1. WIRING DIAGRAMS
2. REMOVAL
3. ASSEMBLY
4. INSPECTION

Wiring diagram 74862

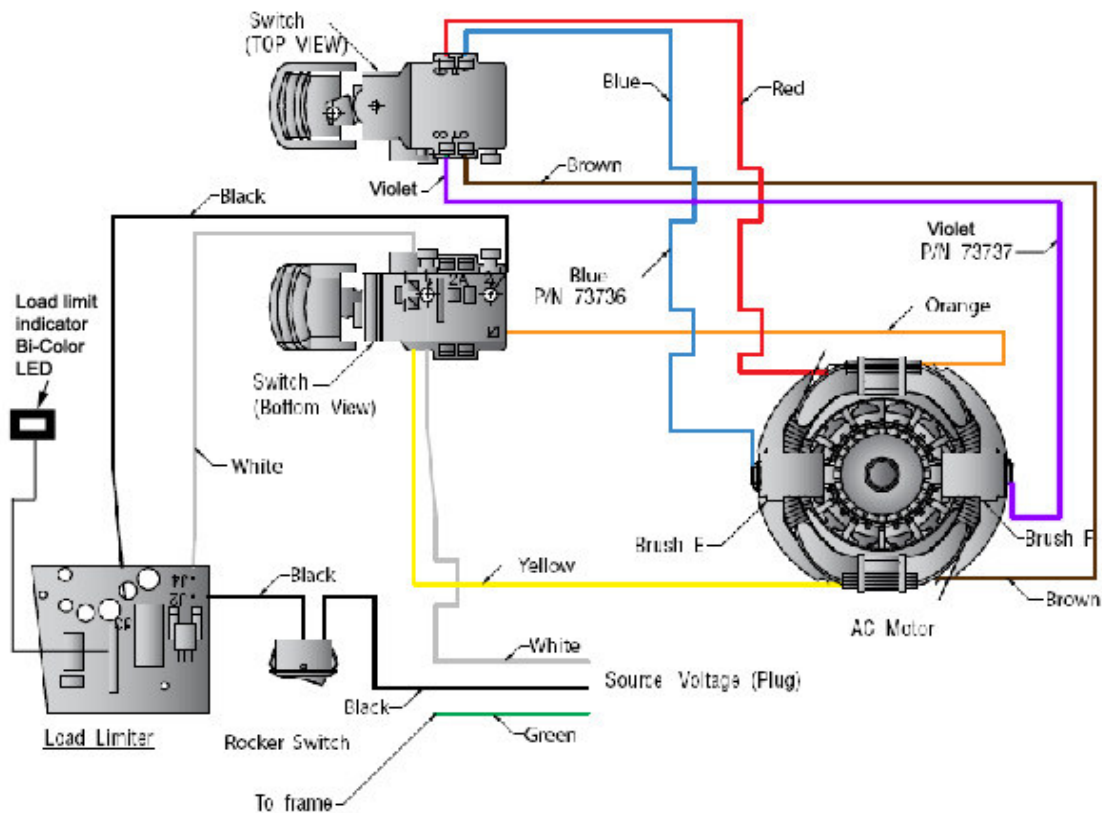

Note: Older models had a circuit breaker instead of the Rocker switch. Wire Routing to the Circuit breaker is identical to the Rocker Switch.

WIRING DETAILS

- Route black lead Wire from J3 terminal on Circuit Board through Wire guides up into handle to Trigger Switch.
- Route black lead Wire from J2 terminal on circuit board through Wire guides up to Rocker Switch.
- Route white lead Wire from J4 terminal on circuit board through Wire guides up to Trigger Switch.
- Route the Motor wires as shown.
- Route Brush leads from Brushes up to Trigger Switch.
- Use tie strap to secure Motor Wires and Brush Wires to the right hand frame.
- Attach green Wire from Power Cord assy. to frame as shown.
- Refer Wiring diagram 74862 for installation Wiring schematic.

Switch Pin-out Table

Manufacturer name is embossed on switch.

VAR SPD PIN-OUT		DEFOND	MARQUARDT
TO/FROM	WIRE COLOR	PIN-OUT	PIN-OUT
LOAD LIMITER	BLK	2	2 ↓
MOTOR FIELD	ORN	2a	②
CORD	WHT	1	1 ↓
LOAD LIMITER	WHT	1a	1
MOTOR FIELD	YEL	1a	1
MOTOR FIELD	BRN	3	5
MOTOR FIELD	RED	4	6
MOTOR BRUSH E	VIO	5	8
MOTOR BRUSH F	BLU	6	7

2.9.1 REMOVAL OF WIRING

To remove the wiring follow instructions below:

1. Remove Rocker Switch from Plastic Housing right hand and remove corresponding lead Wires.



2. Remove 2 Retaining Rings using a large flat bladed screw driver. This will release the Power Cord as shown in figure.



3. Remove Power Cord assembly from the Plastic Housing.



4. Remove the Wire leads from Trigger Switch.

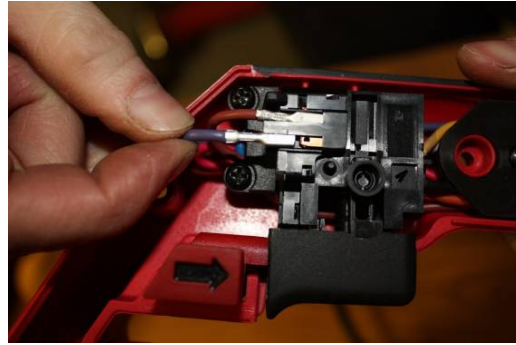

5. ONLY Remove green Ground Lead Wire from Chassis when replacing power cord.



6. Remove the Load limiter Board Assy from Plastic Cover. Check all the connections for proper contact.

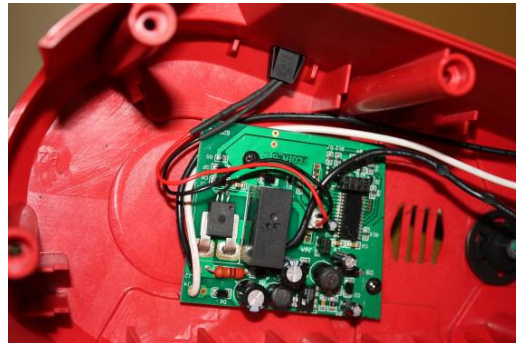

2.9.2 ASSEMBLY OF WIRING

To reassemble the wiring follow the below instructions:

1. Install Load limiter Board Assy to Right hand Plastic Housing.



2. Install LED to Right hand Plastic Housing.



3. Attach green Ground Lead Wire to Chassis. Tighten cap screw and nut.

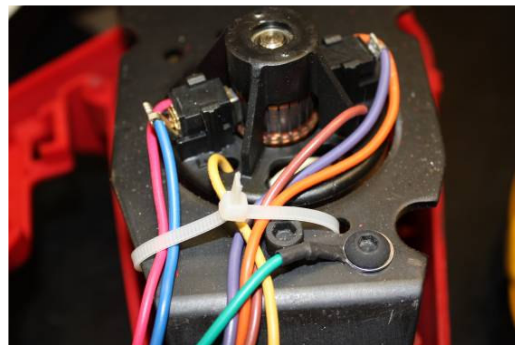

4. Connect lead Wires to correct locations on the Trigger Switch and place the Trigger Switch into the Right hand Plastic Housing.

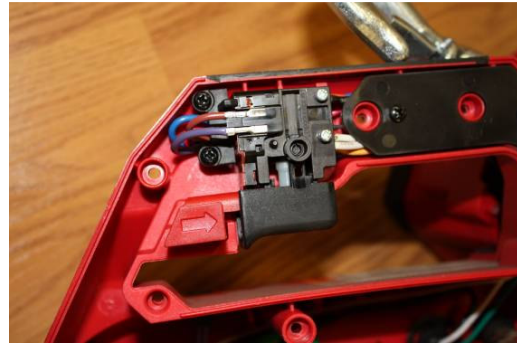

5. Install direction Switch slider properly into the Housing slot related to the Trigger Switch.

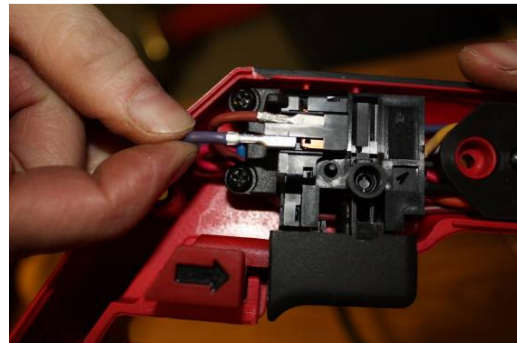

6. Make sure that all lead Wires are routed correctly and connected to Switch correctly.

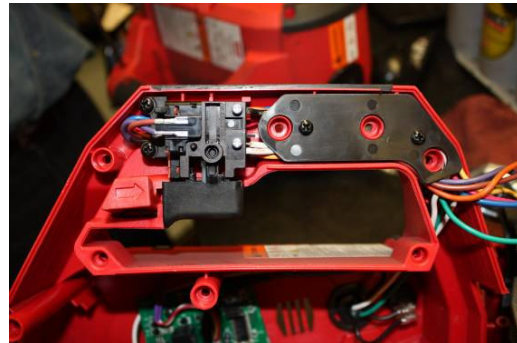

7. Install Power Cord assembly.

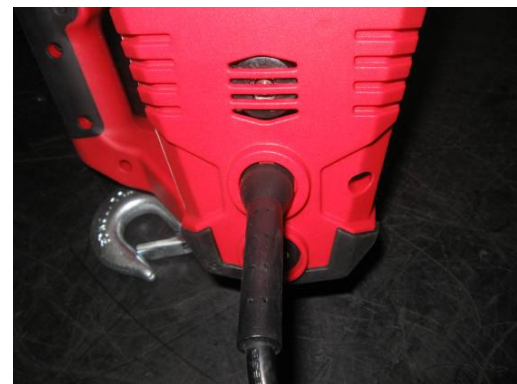

8. Use 2 Retaining Rings to lock Power Cord with the Plastic Housing in opposite direction.



9. Install Rocker Switch to Right Plastic Cover and connect corresponding lead Wires.



2.9.3 INSPECTION OF WIRING

- Visual Inspection.
- Ensure that Switches have assembled correctly. Wiring is complete match the drawing and pin-out table for corresponding switch.
- Ensure that Wiring has not jammed in Housing. Direction Switches slider assembled correctly.
- Ensure green Ground wire is securely attached to chassis.

2.10 TORQUE SPECIFICATIONS

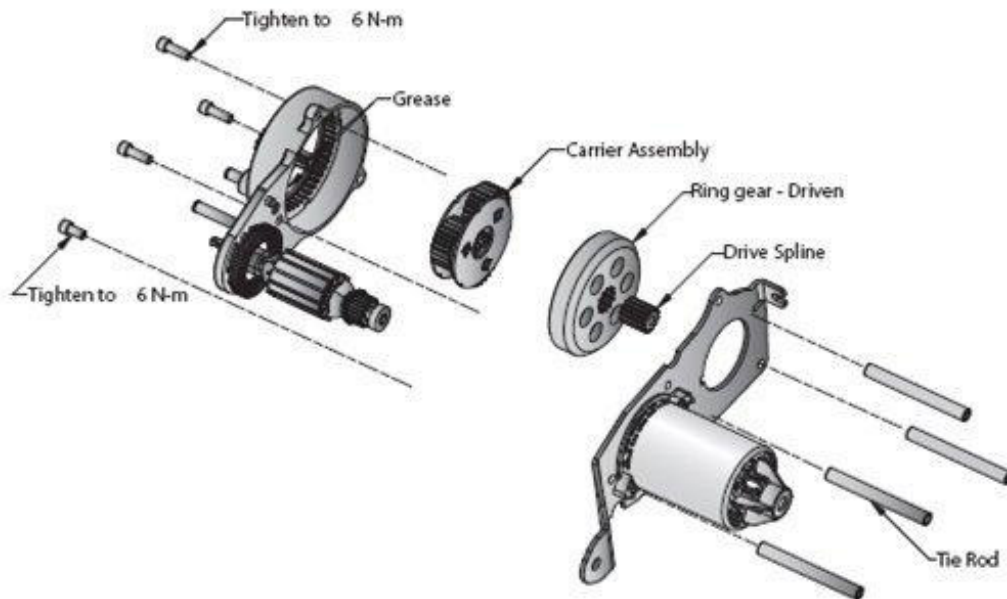
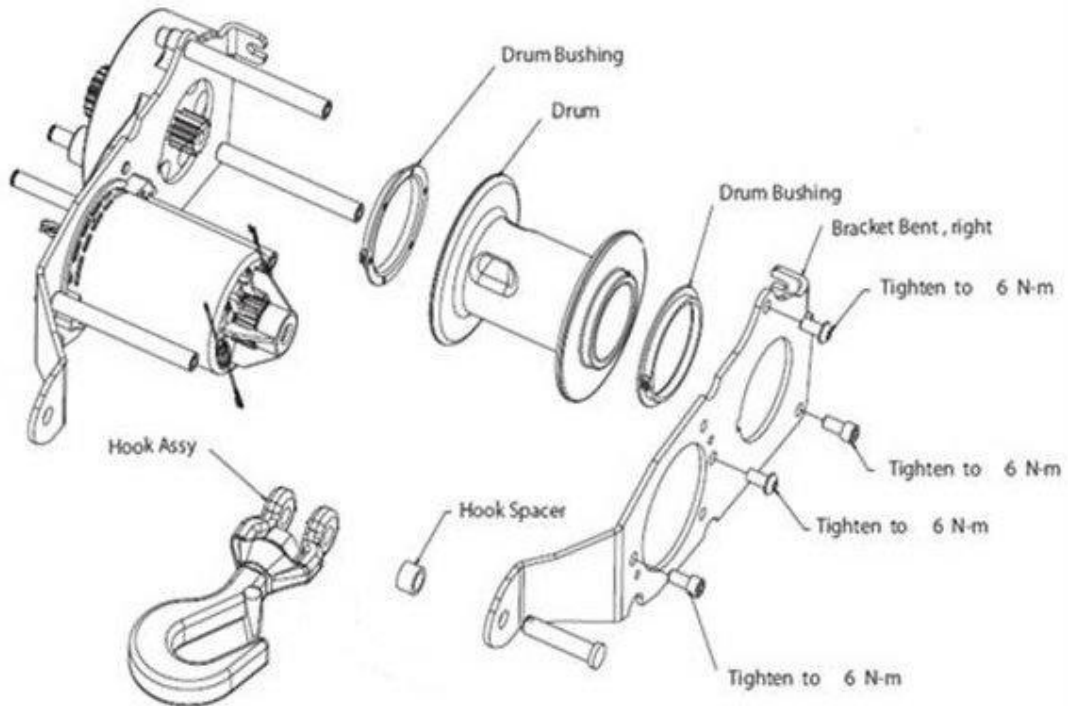

3. PULLZALL TROUBLE SHOOTING

PROBLEM	POSSIBLE CAUSE	CORRECTIVE ACTION
1.1 PullzAll does not power in or pulls slowly.	Loose connection on Motor terminals.	Be sure all connections are tight and clean. Do not let bottom nut or stud turn while tightening.
	Check the speed mode selected.	Change mode as required.
	Burnt main contact point, or poor contacting action.	
	Worn Brushes.	Replace Motor Assembly
	Weakened brush springs.	
	Poor Wiring connections.	
	Rope is interfacing with Tie Rod or other part of PullzAll.	Rewind Rope on Drum, so that it is level and not rubbing on other parts of PullzAll.
1.2 Noise	Motor is hot.	Allow PullzAll Motor to cool for at least 10 minutes between short pulls. Increase cooling time for heavy loads or long pulls.
	Abnormally worn Bushing.	Replace PullzAll.
	Worn or Broken Gearset.	Replace PullzAll
1.3 Motor is running but not pulling.	Motor malfunctioning.	Replace Motor.
	Damaged Geartrain	Replace PullzAll



Motor does not run.	Faulty Trigger Switch	Repair or replace Switch
	Defective Motor	Replace Motor
	Loose connection of the Wires to be Motor terminals.	Secure the Motor terminal and Wires.
1.6 Electrical sparks appear around Motor.	Switch held in power-in position while PullzAll is stalled.	Replace Wire harness or Motor Assembly.
1.7 Wiring harness insulation has melted.	Poor installation caused Wire insulation to be rubbed off or cut, causing direct short.	Replace Wiring harness.
1.8 PullzAll makes squeaking / high pitch noise.	Drum Bushing not lubricated.	Grease Drum Bushings.
1.9 Full speed only, no variable speed control	Ensure trigger is only partially depressed	Replace Variable Speed Trigger switch
1.10 Malfunctioning	Not operating correctly.	Cease operation. Diagnose, Repair or Replace.

INSPECTION

VISUAL INSPECTION:

- While disconnecting the connectors, never pull the wiring Harnesses. Unlock the connector first and then pull them apart by holding connectors themselves.
- While connecting connectors, also hold connectors and put them together until they lock securely (a click is heard).
- While Installing the Wiring Harness, fix it with clamps so that no slack is left.
- While using a tester for checking continuity or measuring voltage, be sure to insert the tester probe from the wire harness side.



4. SERVICE PART LIST

<u>ITEM NO.</u>	<u>DESCRIPTION</u>	<u>PART NO.</u>
1.	Service Part -Motor assembly 120Vac (Includes Motor, Plastic Housing, Brushes & Screws)	77914
2.	Service Part - Variable Speed Trigger,120Vac	77911
3.	Service Part - Load limiter assembly, 120Vac (Includes bi-color LED)	86354
4.	Service Part - Wire rope assembly, PullzAll (Includes fair lead)	76065
5.	Service Part - Tail hook assembly	77930
6.	Service Part - Front Hook assembly	78052

